

# Barrettine

Environmental Health

PEST, ENVIRONMENTAL  
& AGRICULTURAL  
SOLUTIONS

2024/2025



Trusted manufacturer & supplier of  
innovative & sustainable solutions.



# Barrettine

Environmental Health

## PEST, ENVIRONMENTAL & AGRICULTURAL SOLUTIONS



Trusted manufacturer & supplier of innovative & sustainable solutions.



### HOW CAN WE HELP YOU?

Barrettine Environmental Health is the trusted manufacturer and global supplier of innovative and sustainable pest control solutions. Based in Bristol, UK, Barrettine Environmental Health innovate and manufacture integrated pest management solutions to control insect and rodent pests, supplying these throughout sectors such as Professional Pest Management, Waste Management Agriculture and Vector Control. As a division of the Barrettine Group, this affiliated network enhances our capabilities and access to a wealth of collective knowledge and experience in quality manufacturing processes.

Barrettine Environmental Health offers an extensive selection of insecticides designed for controlling flying and crawling insects and a portfolio of monitoring solutions that encompass insect pheromones. The Barrettine product range includes rodent control products that feature patented twin-active rodenticides and rodent proofing solutions as well as novel insecticide free control formulations. Furthermore, we specialise in innovative solutions tailored for the agricultural sector, specifically in crop and grain protection.

These product solutions are dedicated to safeguard the public health, integrity and the quality of commodities in these sectors. Our extensive expertise is complemented by a highly professional service committed to supporting customers.

### OUR COMMITMENT TO OUR CUSTOMERS



**DELIVER EFFECTIVE SOLUTIONS**



**FRIENDLY & KNOWLEDGEABLE SERVICE**



**TRUSTWORTHY & DEPENDABLE**



**MAKING IT EASY FOR YOU**







### SALES & TECHNICAL SUPPORT

Telephone 0117 967 2222  
 Email beh@barrettine.co.uk

### ORDER, PAY & VIEW PRICING ONLINE

[www.barrettineEnv.co.uk](http://www.barrettineEnv.co.uk)

### CUSTOMER SERVICE

[beh@barrettine.co.uk](mailto:beh@barrettine.co.uk)

### REQUEST ACCOUNT

Contact our sales office by email or via our online website account form.

Please be aware you will be required to provide proof of your stewardship certification for compliance purposes.

### CATALOGUE KEY



BPR and other restrictions may apply for Northern Ireland at time of shipping. These products have a PCS or BPD number and may therefore also be cleared for use in Southern Ireland.



Can be sprayed on mattresses.



Video demo available at [www.barrettineEnv.co.uk](http://www.barrettineEnv.co.uk)

### GENERAL CUSTOMER INFORMATION

The information in our catalogue is correct to the best of our knowledge at the time of print but maybe subject to change. We cannot accept any responsibility for loss or damage arising from any error or omission. Certain pictures, charts and text are copyright protected. You should seek permission/approval before copying or using any of the information provided within this catalogue. European Biocides Directive (BPD)/REACH & CLP: Certain products within our catalogue may not be supported fully by the manufacturer through the future stages of the biocides directive/REACH, as such may have to be removed from the market, but we will endeavour to inform all our customers of news as we get it but please check at the time of order if you have any concerns. For the most up to date information, please regularly visit: [www.barrettineEnv.co.uk](http://www.barrettineEnv.co.uk). Alternatively, contact the Sales Office and ask to be added to our news mailing list.

## RODENT CONTROL

RODENTICIDES	5-14
RODENT MONITORING & INDICATOR PRODUCTS	15
RODENT BAIT STATIONS & FIXINGS	16-19
SNAP & CATCH TRAPS PLUS LURES	20-22
LIVE CAPTURE TRAPS & RODENT PROOFING	23-24
RODENT GLUE BOARDS	25-26
DRAINAGE SYSTEMS & HYGIENE	27
PAPERWORK & LABELS	28

## INSECT CONTROL

PESTICIDE FREE & INSECT BAIT	30-36
INSECT TRAPS & TREATMENTS	37-43
INSECTICIDES	44-46
SMOKE GENERATORS & AEROSOLS	48
RURAL & GRAIN STORE HYGIENE	50-51
WOOD PRESERVATION & TREATMENTS	52-53

## BIRD CONTROL

BIRD REPELLENTS & GUANO CLEANING	55-56
BIRD SPIKES	57
BIRD SPIKE CLIPS, SEALANT & TRAPS	58-59

## APPLICATION EQUIPMENT

FOGGERS	62
SPRAYERS, SPRAYER PARTS & ACCESSORIES	63-65
POWDER APPLICATION KITS, DUSTERS & SPARES	66-67
BAIT GUN APPLICATORS	68
TORCHES, DECANTING & MIXING	69

## PPE & SAFETY

PROTECTIVE CLOTHING	71
MASKS, FILTERS & RESPIRATORS	72-73
HYGIENE & DISINFECTANTS	74-75
TECHNICAL INFORMATION	76

# NEW PRODUCTS FOR 2024



LOGIN TO OUR WEBSITE FOR PRICES OR REGISTER NOW

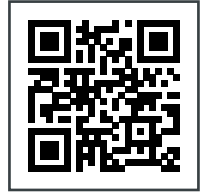

01.  
**MoBe<sup>®</sup> Ant Gel Bait**  
Insect Control

Page 36



02.  
**MoBe<sup>®</sup> Roach Gel Bait**  
Insect Control

Page 36



03.  
**MoBe<sup>®</sup> Ant Station**  
Insect Control

Page 37



04.  
**CropProtect<sup>®</sup> 25EC**  
Insect Control

Page 50



05.  
**Knockout<sup>®</sup> Max  
Strength Disinfectant**  
Hygiene & Disinfectants

Page 74 & 27





# PRICING & SERVICES



## CUSTOMER PRICING

All product pricing is available on our website. Login to your online account to access by scanning the QR Code or go to: [www.barrettineEnv.co.uk](http://www.barrettineEnv.co.uk)



## DON'T HAVE AN ACCOUNT WITH US YET?

Register for free by scanning the QR Code or go to the 'Register' tab on our website homepage.



## BULK PRICING

Contact us for special larger volume pricing. Our sales team will get back to you promptly to review your request.



## BESPOKE COMPANY ONLINE ORDERING FACILITY

It's time to simplify handling the needs of your employees.

Whether it's selecting stock from a pre-approved product list or reporting on stock levels held by your technicians, we've got you covered. Ordering supplies from us is simple for you and your staff. All order requests can be tailored for management approval before dispatch. We can create a custom ordering process designed just for your business. Once approved, your order is sent to our sales team for immediate dispatch.



**Charles Phillips**  
MBA M.Sc  
COMMERCIAL DIRECTOR  
Mobile:  
+44 (0) 7990 507247



**Caroline Ambrosi**  
GENERAL MANAGER  
Mobile:  
+44 (0) 7921 476430



**Will Kirkpatrick**  
UK SALES MANAGER  
Mobile:  
+44 (0) 7516 029491



**Ellen Rogers**  
SALES & EXPORT  
MANAGER  
Mobile:  
+44 (0) 7990 507262



**James Phelps**  
MSci  
PRODUCT MANAGER  
Mobile:  
+44 (0) 7977 456505



**Carly Richards**  
SALES OFFICE  
ADMINISTRATOR



**Sue Hunt**  
CUSTOMER SUPPORT  
ADVISER

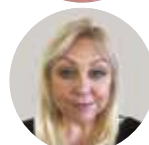

**Beverley Cambridge**  
CUSTOMER SUPPORT  
ADVISER



**Kelly Sharpe**  
CUSTOMER SUPPORT  
ADVISER

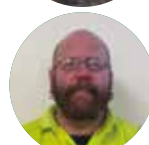

**Hadrian Bridge**  
WAREHOUSE  
MANAGER



**Andy Mills**  
WAREHOUSE  
OPERATIVE

## THE TEAM



# RODENT control

PRODUCTS 

PEST CONTROL CATALOGUE 2024/2025

Products marked up as “Professional” can only be used by professional users holding certification demonstrating compliance with UK rodenticide stewardship regime requirements. Read the label before use. Using these products in a manner that is inconsistent with the label may be an offence. Refer to the CRRU UK Code of Best Practice (or equivalent) for guidance. When this product is supplied to a user for the control of rodents, it shall only be supplied to a professional user holding certification demonstrating compliance with UK rodenticide stewardship regime requirements”.





# BROMADIOLONE & DIFENACOU M

A combined active demonstrating excellent efficacy against rats and mice. Block and pasta formulation contain FLUO-NP, UV tracking technology.

PROFESSIONAL

## ROMAX® MUSKIL® BLOCK



Contains 0.0025 % Difenacou m & 0.0025 % Bromadiolone. For use against rats & mice, in and around buildings. A 25 g wax block manufactured from high-quality food-grade ingredients with a predrilled hole to facilitate easy securing in bait stations. Romax® Muskil® Fluo NP® is formulated with unique Fluorescent No Phobia technology which significantly improves the primary acceptance of the bait resulting in faster kill whilst also allowing for tracking. Permanent baiting approved. Safety - Contains denatonium benzoate

Approval No: GB-2013-0757

1 x 7 Kg

ORDER CODE: BMUSBB7K

### ROMAX® MUSKIL® WAX BLOCK – Proven palatability.

#### RATS

Poisoning phase: daily poisoned bait-take (grams)

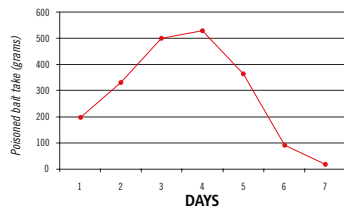

#### MICE

Poisoning phase: daily poisoned bait-take (grams)

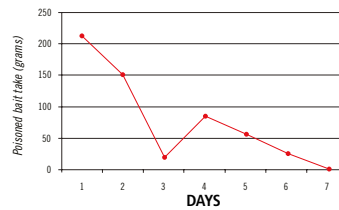

An extruded wax block produced with a central hole for anchoring into bait stations with edges to encourage gnawing. The block which has the unique Romax® Muskil® formulation, makes it highly attractive to both rats and mice while remaining durable in challenging conditions of high humidity and moisture.

PROFESSIONAL

## ROMAX® MUSKIL® PASTA



Contains 0.0025 % Difenacou m & 0.0025 % Bromadiolone. For use against rats & mice, indoors and outdoors. A 15 g sachet containing pasta manufactured from high-quality food-grade ingredients that can be secured in bait stations. Romax® Muskil® Fluo NP® is formulated with unique Fluorescent No Phobia technology which significantly improves the primary acceptance of the bait resulting in faster kill whilst also allowing for tracking. Permanent baiting approved. Safety - Contains denatonium benzoate

Approval No: GB-2013-0756

1 x 4 Kg

ORDER CODE: BMUSPA4K

### ROMAX® MUSKIL® PASTA – The fastest solution.

Laboratory tests show speed of kill compared with other actives.

#### RATS

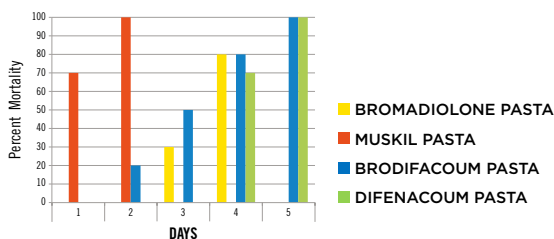

#### MICE

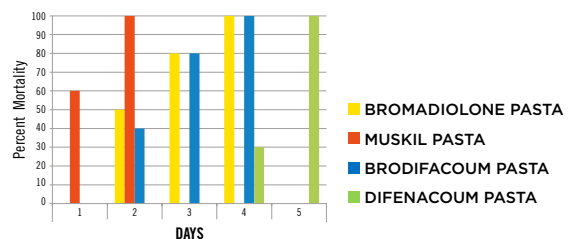

Field tests and commercial usage in Europe has proven that Romax® Muskil® pasta is the fastest solution for controlling both rats and mice. The bait is packed in single dose filter bags which preserves the attracting characteristics effectively maintaining the palatability and performance in a wide range of environments.

# ROMAX<sup>®</sup> MUSKIL<sup>®</sup>

**FLUO-NP<sup>®</sup>**  
UV TRACKING TECHNOLOGY

REVOLUTIONARY

**TWIN ACTIVE**

BROMADIOLONE DIFENACOUM

SPEED OF KILL MORE THAN TWICE AS FAST  
COMPARED TO OTHER ACTIVES TESTED

UV TRACKING TECHNOLOGY **FLUO-NP<sup>®</sup>**  
TRACE TO THE SOURCE

LESS BAIT PER PROGRAMME  
MORE COST EFFECTIVE

RAPID BAIT ACCEPTANCE  
QUICKER CATCH TIMES

**CONTAINS:**

DENATONIUM BENZOATE 0.001% (w/w)  
BROMADIOLONE 0.0025% (w/w)  
DIFENACOUM 0.0025% (w/w)



**PASTA**



**BLOCK**

## FORMULATIONS

PATENTED  
FORMULATION



Barretline Environmental Health, Unit 4 Caxton Business Park, Crown Way, Warmley, Bristol BS30 8XJ.  
T: 0117 967 2222 E: beh@barretline.co.uk www.barretlineEnv.co.uk

**Barretline**  
Environmental Health

ROMAX<sup>®</sup> is a registered trademark of Barretline. MUSKIL<sup>®</sup> and FLUO-NP<sup>®</sup> are registered trademarks of Zapi S.P.A.  
USE BIOCIDES SAFELY. ALWAYS READ THE LABEL AND PRODUCT INFORMATION BEFORE USE.



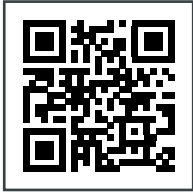

# BRODIFACOUM

Read product label fully to understand the directions on use before application or treatment.

PROFESSIONAL

## ROMAX® VENOM LIPOGEL



The Romax® Venom Lipogel combines Brodifacoum within an increased water activity formulation offering rapid efficacy and the convenience and capacity of rapid baiting. The availability of Brodifacoum in this format gives rapid absorption into soft tissues. For use 'in and around buildings' for rats and mice.

Approval No: GB-2016-1041-0002

10 x 300 g

ORDER CODE: BVLIPBRD

PROFESSIONAL

## ROMAX® VENOM BLOCK



Containing the most potent anticoagulant active ingredient, Romax® Venom is a ready-to-use 25 g wax block with 0.005 % (w/w) Brodifacoum for effective control of mice and rats. Rodents' death occurs after a few days (3 to 5) from a single feed without rousing suspicion towards the bait by the other members of the colony.

Approval No: GB-2015-0880-003

1 x 5 Kg

ORDER CODE: BVBBROD5

PROFESSIONAL

## ROMAX® VENOM PASTA SACHET



The Romax® Venom formulation of Brodifacoum made with Italian pasta is presented in sachets that can be attached or skewered within the bait box. Approved for use 'in and around buildings' for rats and mice.

Approval No: GB-2015-0881-005

1 x 3 Kg

ORDER CODE: BVPBROD3

# Whilst you are here... Follow us on Facebook!

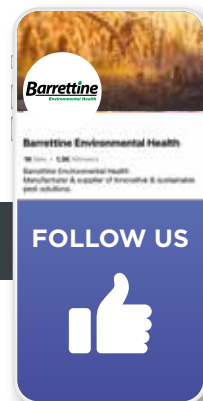

GROWING COMMUNITY



EXPLORE OUR WEEKLY POSTS



LATEST PRODUCTS & PROMOTIONS

# When it's time to bite the bullet



## HIGH POTENCY ACTIVE for Rapid Rodent Baiting & Control

To be used in conjunction with a dynamic IPM strategy.

- ✓ Rapid absorption into soft tissue
- ✓ Controls rats & mice In and around building
- ✓ High water activity



ROMAX®  
**VENOM**  
UNIQUE  
**LIPOGEL BAIT**

The Romax Venom Lipogel combines Brodifacoum within an increased water activity formulation offering rapid efficacy as well as the convenience and capacity of rapid baiting. The availability of this range includes five products: **Lipogel, Wheat, Pasta, Block** and **Fresh Bait** formulations.







# BRODIFACOUM

## PROFESSIONAL ROMAX® VENOM WHEAT



The Romax® Venom active ingredient is infused within the core of the seed, giving a product and active, that when consumed is particularly potent to rodents. Approved for use 'in and around buildings' for rats and mice.

Approval No: GB-2015-0881-004

1 x 4 Kg	ORDER CODE: BVWBRD4K
1 x 10 Kg	ORDER CODE: BVWBRD10

# ROMAX® VENOM WHEAT



ROMAX® VENOM WHEAT is a ready-to-use bait for the control of house mice and brown rats at all development stages containing a highly potent compound: brodifacoum, a single-feed, second-generation anticoagulant active ingredient. Thanks to its mode of action, rodents' death occurs without rousing suspicion towards the bait by the other members of the colony.

ROMAX® VENOM WHEAT is a rodenticide bait consisting of decorticated wheat, manufactured with SAT (Special Absorption Technology) technology, allowing the homogeneous distribution of the active ingredient both inside and on the surface of the grain. This bait is ideal for treatments when rodents' diet is mainly based on grains/corn seeds consumption, such as in rural and zoo-technical buildings, and particular civil and industrial areas (feed production, flour processing, mills, etc.). The product contains a well-balanced mix of food-origin components attractive for the rodents' species previously mentioned and incorporates a bittering agent (Denatonium Benzoate) to help prevent human consumption.

### KEY BENEFITS:

- Ready-to-use rodenticide grain bait.
- Brodifacoum is a single feed, synthetic, second-generation anti-coagulant rodenticide.
- When compared to other anticoagulant rodenticides, brodifacoum has an excellent level of activity against the brown rat, and against mice.
- This is an aggressive single feed poison.
- potent poison to all mammal species and it is essential that all baits are only used indoors, and they must be well protected from non-target animals. The best way to achieve this is by placing the baits in an approved bait box.

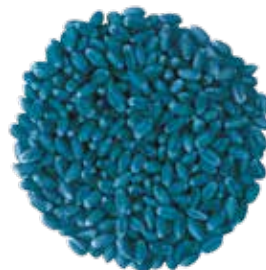

# CHOLECALCIFEROL

Cholecalciferol has no known resistance making it a good choice if resistance is suspected.

# RODENT control

PRODUCTS 

PROFESSIONAL

## HARMONIX RODENT PASTE



Harmonix® Rodent Paste is a high-performance ready-to-use non-anticoagulant rodenticide bait containing Cholecalciferol 0.077 % w/w (0.075 % w/w pure) for the control of rats and mice for the protection of public health, stored products and materials.

Harmonix® Rodent Paste is an incredibly flexible product that provides the professional pest controller treatment options in a wide number of scenarios. Harmonix® Rodent Paste is not limited to 'in and around buildings', and the active ingredient Cholecalciferol has no known resistance making it a good choice if resistance is suspected.

Approval No: GB-2020-1266; IE/BPA 70695

1 x 5 Kg

ORDER CODE: BHARPAST

# COUMATETRALYL

Excellent efficacy against rats and demonstrates reduced risks of secondary poisoning.

# RODENT control

PRODUCTS 

PROFESSIONAL

## RACUMIN FOAM

IR



Contains 0.4 % (w/w) Coumatetralyl. Racumin® Foam is a new, non-bait rodenticide from Bayer, offering an alternative method to control rat and mice infestations. This truly innovative foam formulation works with the rodent's natural grooming habits and is effective as a result. When faced with difficult to access areas, Racumin® Foam is for indoor use and can be applied in known rat runways, passages, entrance points / holes, covered tracks and wall cavities.

Approval No: GB-2014-0860

Supplied with free contact station, pictured below.

FREE ROMAX® CONTACT STATION

1 x 500 ml

ORDER CODE: BRACFO.5

## ROMAX CONTACT STATION



Allows contact rodenticides to be applied within the station to allow rodents to come into contact with the active ingredients. Following the rodent control program, the contact stations can be conveniently removed. The unique design incorporates end flaps on either side of the station that has the effect of increasing the transfer area of the active ingredient to the coat of the rodent as the rodent passes through the station.

1 x 4

ORDER CODE: BBBROCT4





# BROMADIOLONE

Bromadiolone is a second generation anticoagulant offering a high degree of potency. Available in many formulations.

PROFESSIONAL

## ROMAX® B WHOLE WHEAT



Contains 0.005 % Bromadiolone for use against rats & mice. Romax® is formulated using high-quality food grade whole wheat, blended with feeding enhancers and adjuvants to improve palatability. The wheat is also treated to prevent germination which increases the quality of the product without affecting its palatability.  
Safety - Contains denatonium benzoate

Approval No: GB-2014-0826-0005

1 x 10 Kg

ORDER CODE: BRBROM10

PROFESSIONAL

## CONTRAC ALL-WEATHER BLOX

IR



Contains 0.005 % (w/w) Bromadiolone plus Bitrex. A 28 g second generation, multi-edged rat and mouse bait manufactured through a unique extrusion process that yields bait unsurpassed in rodent acceptance and control. Formulated with a special blend of food-grade ingredients and low wax content, Contrac BLOX stays fresh and palatable in wet and dry areas. IR(93432). Permanent baiting approved.

Approval No: GB-2015-0941

Standard pallet of 36

1 x 8 Kg

ORDER CODE: BCOBX008

PROFESSIONAL

## DEADLINE RAT & MOUSE WHEAT

IR



Contains 0.005 % Bromadiolone on whole wheat. For use in dry and damp locations. Specially treated to remain fresh and palatable when used in damp locations. IR(95181)

Approval No: GB-2014-0826-0002/NI-2014-0826-0002

1 x 10 Kg

ORDER CODE: BDEAD010



### CUSTOMER PRICING

All product pricing is available on our website. Login to your online account to access by scanning the QR Code or go to: [www.barrettineEnv.co.uk](http://www.barrettineEnv.co.uk)



### DON'T HAVE AN ACCOUNT WITH US YET?

Register for free by scanning the QR Code or go to the 'Register' tab on our website homepage.



### BULK PRICING

Contact us for special larger volume pricing. Our sales team will get back to you promptly to review your request.



# DIFENACOU M

Difenacou m is a second generation active ingredient.  
A high degree of potency - available in a wide range of formulations.

# RODENT control

PRODUCTS 

PROFESSIONAL

## ROMAX® D WHOLE WHEAT



Contains 0.005 % Difenacou m. For use against rats & mice, indoors and around buildings. Romax® is formulated using high-quality food- grade whole wheat, blended with feeding enhancers and adjuvants to improve palatability. The wheat is also treated to prevent germination which increases the product's quality without affecting its palatability. Safety - Contains denatonium benzoate

Approval No: GB-2011-0143-0002

1 x 10 Kg

ORDER CODE: BRDIFE10

PROFESSIONAL

## ROMAX® D 50 g WHOLE WHEAT SACHETS



Contains 0.005 % Difenacou m. Whole wheat packed in 100 x 50 g sachets. The sachets do not need to be opened as the rodents will eat through the packaging material. Safety - Contains denatonium benzoate

Approval No: GB-2011-0143-0002/NI-2011-0143-0002

1 x 5 Kg

ORDER CODE: BRDIFSA5

PROFESSIONAL

## ROMAX® D BLOCK



Contains 0.005 % Difenacou m. A highly palatable 20 g block. Safety - Contains denatonium benzoate

Approval No: GB-2011-0065-0002

1 x 5 Kg (UK)

ORDER CODE: BRODBLOX



PROFESSIONAL

## ROMAX® DP PASTE



Contains 0.005 % (w/w) Difenacou m. Romax® DP is a high-calorie bait that has been specially formulated to offer extraordinary palatability and control problem mice infestations - based on a mixture of oils and attractive food bases.

Approval No: GB-2013-0804

12 x 300 g

ORDER CODE: BRDP300G

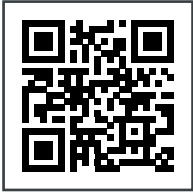

# DIFENACOUM

Difenacoum is a second generation active ingredient. A high degree of potency - available in a wide range of formulations.

PROFESSIONAL

## DEADLINE RAT & MOUSE WHEAT



A high quality whole-wheat based anticoagulant rodenticide to control rats and mice in both indoor and around buildings. Specially formulated to resist the growth of mould and remain highly palatable.

Approval No: GB-2011-0143-0001

1 x 10 Kg

ORDER CODE: BDEDIF10

PROFESSIONAL

## DEADLINE DIFENACOUM PASTE



A very attractive wheat-based paste formulation for the control of mice in tamper-resistant bait boxes. Easy to apply with little wastage.

Approval No: GB-2011-0148

12 x 300 g

ORDER CODE: BDEADDPS

# RODENT control

PRODUCTS

# DIFETHIALONE

PROFESSIONAL

## RODILON® WHEAT TECH 25ppm



Ideal for rat control, Rodilon® Wheat Tech uses the highest quality whole wheat grain making it extremely palatable and increases consumption. It is perfect for difficult to control infestations throughout a wide range of baiting situations.

Approval No UK: GB-2011-0049-0001  
Approval No IRELAND: IE/BPA 70569-001

1 x 10 Kg

ORDER CODE: BRODWT10



# FLOCOUMAFEN

A very potent rodenticide reaching similar efficacy levels to that of Brodifacoum.

# RODENT control

PRODUCTS 

PROFESSIONAL

## STORM® SECURE BAIT BLOCKS

IR



Contains 0.005 % Flocoumafen. Storm is a highly potent anticoagulant rodenticide that is effective against both rats and mice, including resistant strains. Storm is available as a 20 g block packed in 3 kg and may also be used in sewers and covered drains where their resistance to mould growth make them particularly suitable. Approved for Pulse baiting. IR(93137)

Approval No: GB-2015-0850

1 x 3 Kg

ORDER CODE: BSTBB003

PROFESSIONAL

## STORM® ULTRA SECURE



Contains 0.0025 % Flocoumafen. Storm Ultra is a highly effective new addition to the successful line of Storm® products. At least twice as palatable as leading anticoagulant block baits, Storm Ultra is stable and durable enough to withstand extreme temperatures. Storm Ultra features a patented formulation employing an innovative BASF binder with superior performance. Approved for pulse baiting and burrow baiting.

Approval No: GB-2018-1164-0001

1 x 3 Kg

ORDER CODE: BSTULTRA

# ALPHACHLORALOSE

Single feed indoor rodenticide registered for mice.  
The active ingredient has anaesthetic and sedative properties.

# RODENT control

PRODUCTS 

PROFESSIONAL

## ALPHA EXPRESS BLOCKS



Alphachloralose is an acute-acting active substance that has been newly formulated and especially designed for use in tamper-resistant bait boxes. For fast and effective control of mice indoors in a wide variety of locations. Only a small scratch from a mouse's incisors on the block's surface is sufficient, and just 'sampling' of the bait is often enough to kill.

Approval No: GB-2013-0803

48 x 5 g

ORDER CODE: BALPHBLX

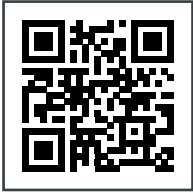

# MONITORING & INDICATOR PRODUCTS

## ROMAX® FLUORESCENT TRACKING DUST

A rodent detector system that uses tracking dust that fluoresces in "black light" (ultraviolet).



1 x 250 g  
Yellow

ORDER CODE: BTRDU250

## UV TRACKER TORCH

Ideal for use with tracking dusts, non-toxic fluorescent baits and fluorescent rodenticides.



Each

ORDER CODE: BUVTLAMP

## DETEX BLOX WITH LUMITRACK

Reformulated using Lumitrack, droppings glow bright green under UV light. Highly palatable non-toxic monitoring bait. There is now a demand from food manufacturers and large industrial businesses to monitor constantly for rodents with non-toxic bait. Detex Blox fits perfectly into this situation. The new Detex Blox from Bell contains a fluorescent marker which glows under UV light to aid with tracking infestations.

Standard outer 2



1 x 4 Kg

ORDER CODE: BDEBX004

# Save time, place your order online.



## PAY ONLINE

[BarrettineEnv.co.uk](http://BarrettineEnv.co.uk)

RODENT CONTROL - MONITORING & INDICATOR PRODUCTS

# RODENT BAIT STATIONS



LOGIN TO OUR WEBSITE FOR PRICES

OR REGISTER NOW

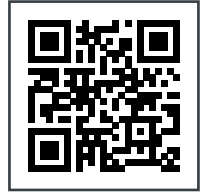

## ROMAX® RODENT BAIT BOX



The Romax® rodent bait station is a high-quality, tough, injection moulded bait box. The Romax® rodent bait station features our unique locking mechanism, making it an ideal solution for internal and external baiting using bait blocks, grain or wheat, pasta sachets and paste/gel. Romax® rodent bait stations can also be used with physical control methods such as Snap traps etc. Own branding available; contact the office for further information.

1 x 6

ORDER CODE: BBBROSTD

Spare Metal Bar

ORDER CODE: BPINBARS

## ROMAX® METAL & PLASTIC BAIT BOX KEY



**METAL** - Heavy duty metal key for use with Romax® rat bait boxes. Can also be used with Romax® mouse boxes.

**PLASTIC** - Replacement bait box keys for use with Romax® rat and mouse bait boxes.

Each - Metal

ORDER CODE: BBBRKEYM

Each - Plastic

ORDER CODE: BBBRTKEY

## WEILS CARD



Working in close proximity to rodents increases the risk of coming into contact with *Leptospira* bacteria, a potentially lethal bacterial infection that causes Leptospirosis or Weil's disease. Carry this robust Weils disease card in your wallet to inform and enable a Medical Practitioner to either eliminate this disease from the presented symptoms or initiate treatment.

Each

ORDER CODE: BWEILSCR

## BESPOKE COMPANY ONLINE ORDERING FACILITY

It's time to simplify handling the needs of your employees.

Whether it's selecting stock from a pre-approved product list or reporting on stock levels held by your technicians, we've got you covered. Ordering supplies from us is simple for you and your staff. All order requests can be tailored for management approval before dispatch. We can create a custom ordering process designed just for your business. Once approved, your order is sent to our sales team for immediate dispatch.

>> Save time >> Save money >> Streamline your process!

Contact our team and enquire today.





# BOX CLEVER

ROMAX<sup>®</sup>

MOUSE BOX

Advanced bait  
securing system

Optional inbuilt  
insect monitor

Single key for the  
complete range

Unit 4, Caxton Business Park, Crown Way, Warmley, Bristol, BS30 8XJ  
T: 0117 967 2222 E: beh@barrettine.co.uk [www.barrettineEnv.co.uk](http://www.barrettineEnv.co.uk)

**Barrettine**  
Environmental Health

USE BIOCIDES SAFELY. ALWAYS READ THE LABEL AND PRODUCT INFORMATION BEFORE USE.

# MOUSE BAIT STATIONS

## ROMAX SNAP-R MOUSE BOX



The Romax Snap-R Mouse Bait Station is the best compact mouse trap and bait station available. Because of its small size and high strength, it is suitable for use indoors, including sensitive areas such as food & pharmaceutical manufacturing areas and where there is a lot of footfall or vehicle movement.

- Secure, tamper-proof lock system
- Inspection window for easy inspection
- Can be fixed using wall-tethers
- Compartment to secure Snap-R Mousetrap

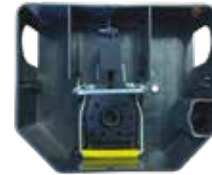

1 x 28

ORDER CODE: BSNAPRAT

## ROMAX® MOUSE BOX



A stylish, durable and practical mouse box, the Romax® mouse box has a number of unique bait safety features. The box itself is priced very competitively, but by adding the novel, optional Romax® 'false floor' the unit can also double up as an integrated insect monitor with a combined cost of almost half that of similar separate bought units. **Embossing available** - Please contact the office for a quote.



1 x 24

ORDER CODE: BBBROMOU

Bait Box Key

ORDER CODE: BBBRTKEY

## ROMAX® INSECT 'FLOOR'

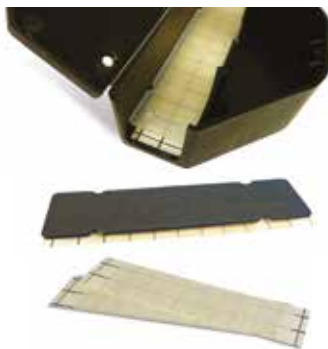

A unique false floor designed to fit in the entrance to the Romax® mouse box. The clever design allows a pre-baited insect monitor to be placed underneath, and insects can be detected underneath whilst the mice walk over the top to the bait. Independently tested to catch insects up to the size of an oriental cockroach and available in black or clear (or bespoke!)

1 x 24 (Black)

ORDER CODE: BBBROMFL

1 x 24 (Clear)

ORDER CODE: BBBROMFC

1 x 100  
Sticky Pads

ORDER CODE: BBBROMIM

## ROMAX® CARDBOARD BAIT BOX



For mouse baits. Heavy-duty board, internally and externally laminated for water resistance. Own branding is available, call the office for further information.

1 x 100

ORDER CODE: BBBCARDB

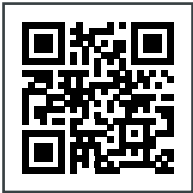

  
**LOGIN TO OUR WEBSITE FOR PRICES**  
**OR REGISTER NOW**

# INTERNAL BAIT BOX FIXINGS

## BAIT BOX ANCHOR KITS

Bait box fixing point with industrial-strength adhesive and wire for ease of installation. Option with clip so that boxes can be removed for servicing then re-installed.



**1 x 10**  
(without clip)

**ORDER CODE: BBBANKIT**

## PLASTIC BAIT TRAYS

Thermo-formed moulded plastic - (Approximate dimensions)

**RED** - Medium oblong (100 mm x 115 mm x 26 mm deep).  
**WHITE** - Large oblong (150 mm x 220 mm x 38 mm deep).



**1 x 100**  
(Red)

**ORDER CODE: BBBTRMED1**

**1 x 100**  
(White)

**ORDER CODE: BBBTRLGE1**

## TECHNICIANS FIELD GUIDE

A complete and essential guide for the professional.

- FLYING INSECTS
- CRAWLING INSECTS
- RODENT PESTS
- BIRD PESTS
- SPI, AGRICULTURE & AMENITY PESTS

The Barretttine's pocket-size A6 Pest Technicians guide contains detailed information to assist in the daily routine of a Professional Pest Control Operator. A 'how to' guide covering topics of insect and rodent information and identification, equipment calibration, non-chemical insect control measures, pesticide application and product safety, dealing with waste: Triple rinsing as well as detailed information on LD<sub>50</sub>.

**ORDER CODE: BPIDBOOK**





# SNAP TRAPS

## ROMAX® SNAP-R RAT TRAP



The Romax® Snap-R Rat Trap is highly effective at trapping rats. Detachable tag allows traps to be secured if required.

Each

ORDER CODE: BSNAPRTR

## ROMAX® SNAP-R MOUSE TRAP



The Romax® Snap-R mouse trap combines an effective mousetrap mechanism with rugged materials, the Snap-R is simple, durable and effective. Please note colour of strike bar may vary.

Each

ORDER CODE: BSNAPMTR





# RODENT DETERRENT & LURES

## ANTI-RODENT LACQUER



Quick-dry formulation for surface treatment to deter rodent pests from chewing or biting treated areas. Anti Rodent Lacquer contains a quick-dry formulation that forms a water-resistant protective film over the treated surface. Simply spray on the area under attack by rats or mice - rodents will be deterred from chewing or biting into the treated area. Contains a bittering agent and natural plant oils. Ideal for use in and around domestic and commercial properties, as well as on farms and other agricultural premises.

- Provides up to 6 months protection to treated areas.
- Indoor and outdoor use.
- Suitable for application to hard surfaces, including electric cabling and insulation.
- Contains peppermint oil, castor oil and bittering agent.

1 x 600 ml

ORDER CODE: BRODLACQ

## TRAPPING GUIDELINES FOR RODENTS

Whilst the use of traps is labour intensive, they have a part to play in rodent control, particularly for controlling very small infestations in circumstances where the use of rodenticides is unacceptable. They are unlikely to contribute significantly to large scale control programmes. The major reason for their limited applicability is the behaviour known as neophobia. If large scale control using traps is essential, then the trapping programme needs to be very intensive and very closely monitored.

The use of break-back traps for both rats and mice is probably the most widespread and successful trapping technique. Careful placement is required with break-back traps, the treadle end of the trap being placed across the rodent run against a vertical surface to minimise avoidance. Bait does not need to be used and may reduce the effectiveness of the trap.

All traps should be visited at least once every 24 hours to remove any dead rodents, reset the traps, and ensure that no rodents are being held alive.

One further form of trapping is the use of 'Glue-boards'. These are sheets of material, such as hardboard or plastic, on which a specially designed sticky substance or 'rodent glue' is spread. The boards are placed in strategic areas of rodent activity in the event that rodents will become stuck on the boards and can then be humanely killed and removed.

Rodent boards should only be regarded as a 'last choice' option.

The new 'Alliance' Code of Practice on the responsible use of this technique can be found in the glue board section.

For more information visit: <https://www.pmalliance.org.uk/download/humane-use-of-rodent-glue-boards/>

## SPRING TRAPS GENERAL USE

The law requires that spring traps must be set in natural or artificial tunnels, to reduce the risk of killing non-target species. Natural tunnels such as burrows roots may be used, or artificial tunnels, about 60 cm long, can be made from turf, rocks, pipes, boards or fallen timber. This tunnel must be large enough to allow the trap's arms to swing and close, but the tunnel entrance should be reduced to a width of suitable size for the target species by driving sticks into the ground, to exclude pets and other wild mammals and birds. Squirrels will investigate such tunnels and catches may be made throughout the year, particularly in winter and spring. Baiting is unnecessary but will improve catches.

Traps should be placed with the trigger in the middle of the tunnel and should be bedded in flush with the floor. They should be inspected daily and sprung once a week to prevent seizing due to rust. All traps should be securely anchored.

The Spring Trap Pests Act 1954 makes it an offence to use a spring trap for the purposes of killing or taking animals in England and Wales other than one approved by an Order of the Secretary of State. The approval of traps is a devolved issue.

Traps that are currently approved in England are specified in the latest version of The Spring Traps Approval Order 1995. Only traps that have been approved for the purpose may be used.

Those commonly available from Barretine are the Fenn MK4 & MK6, BMI Body Grip, WCS Tube Trap, Mole Trap, Talpex, Talpirid and Putange may also be used if available. Spring traps should not be used in areas where protected species such as red squirrels or polecats may be present.

# MOLE & SQUIRREL TRAPS

## MOLE TRAP HALF BARREL (DUFFUS)

A very popular trap for moles with good effectiveness in burrows.



Each

ORDER CODE: BTRMOLBA

## TALPEX<sup>®</sup> MOLE TRAP

Arguably the best mole trap on the market. Similar to the scissor and pincer traps but more robust. Steve Caple producer of the "Trapping Techniques" video confirmed the following; "Since switching to the Talpex trap my catch rate compared to the more commonly used traps has increased by at least 50 %".



Each

ORDER CODE: BTRMOTAL

## FENN TRAP MARK 4

### FENN TRAP MARK 4

For squirrel, rat or stoat. The trap is to be set in runs or burrows. A artificial surround or tunnel should be created around the trap to protect non-target species.



Mark 4 - Each

ORDER CODE: BTRAFEN4

## BESPOKE COMPANY ONLINE ORDERING FACILITY

It's time to simplify handling the needs of your employees.

Whether it's selecting stock from a pre-approved product list or reporting on stock levels held by your technicians, we've got you covered. Ordering supplies from us is simple for you and your staff. All order requests can be tailored for management approval before dispatch. We can create a custom ordering process designed just for your business. Once approved, your order is sent to our sales team for immediate dispatch.

>> Save time >> Save money >> Streamline your process!

Contact our team and enquire today.



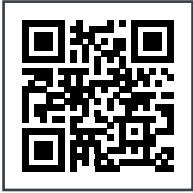

# LIVE CAPTURE TRAPS & PROOFING

## MOUSE MESH GRILLS

Easy to install this professional and sleek design is a great preventative measure to stop a wide range of pests from entering buildings. With its weather resistant ABS frame and stainless steel mesh-mouse mesh grills can stop mice and wasps from entering building structures via air bricks.



Medium (9"x 7")	
Brown	ORDER CODE: BMOBMBRM

## WELD MESH



Galvanised weld mesh is a self-colour weld mesh that has been coated in a liquid galvanise. Generally used for external projects or areas of moisture and available in different sized mesh, as well as lengths and widths.

Please contact the sales office for a quote based on your requirements.

6.5 mm Mesh	
6 m x 0.9 m	ORDER CODE: BBMIS077

## WIRE WOOL



Ideal for restricting access to mice around small holes and gaps such as around pipes.

1 x 450 g	ORDER CODE: BWIRWOOL
-----------	----------------------

## ROMAX® RODENT SEAL



Romax® Rodent Seal uses a top-quality industrial sealant in a patented mix of stainless steel fibres. The benefits of such 'wire wool' plus proofing materials have long been known, but they've been combined to offer a professional and time-saving solution to exclusion for the first time. In addition, the product has been commercially tested and is 'metal-detectable', making it a good choice for sealing around plant and machinery in the food industry, whether this be for rodents, insects or just housekeeping. Standard outer 25

1 x 310 ml	ORDER CODE: BRORODSE
ROTATING ADJUSTABLE NOZZLE	
1 x 5	ORDER CODE: BRORONOZ



# ROMAX<sup>®</sup> RODENT SEAL

**SEALING THE ENTRY POINTS**  
is an essential and cost-effective prevention solution.

**Key Benefits:**

- Contains metal fibre technology encapsulated within a silicone body to prevent erosion of the wire fibres.
- It doesn't have to be re-applied every year.
- Can be used indoors and outdoors, around buildings.
- Fire/heat and UV resistant.
- Maintains structure once applied.
- Cures on exposure to form an elastic silicone rubber.
- Prevents access to rodents: seals gaps, cracks and openings of many sizes.



Barrettine Environmental Health  
Unit 4 Caxton Business Park, Crown Way, Warmley, Bristol BS30 8XJ.  
T: +44 (0) 117 967 2222 E: beh@barrettine.co.uk www.barrettineEnv.co.uk

**Barrettine**  
Environmental Health

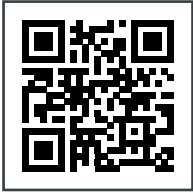

# RODENT GLUE BOARDS

## ROMAX® RAT GLUE BOARD



Barrettine has long campaigned that glue boards should be available to professional users only, and to encourage responsible use of these valuable last resort tools, we have launched a new 'professional only' Romax® glue board - As well as a modern design, the product has the added benefit of the code of conduct and guidelines printed inside- along with their professional only recommendation. For efficacy & humaneness, it's also made to the highest specification to minimise the risk of escape. Each board is wrapped individually.  
**Standard Boards (23 cm x 19 cm)**  
**Large Boards (33 cm x 21 cm)**

Please note the use of glue boards is prohibited in Wales.

1 x 48 - Rat

ORDER CODE: BRMXGBOA

## ROMAX® MOUSE GLUE BOARD



Barrettine has long campaigned that glue boards should be available to professional users only, and to encourage responsible use of these valuable last resort tools, we have launched a new 'professional only' Romax® glue board - As well as a modern design, the product has the added benefit of the code of conduct and guidelines printed inside- along with their professional only recommendation. For efficacy & humaneness, it's also made to the highest specification to minimise the risk of escape. Each board is wrapped individually.  
**Standard Boards (23 cm x 19 cm)**  
**Large Boards (33 cm x 21 cm)**

Please note the use of glue boards is prohibited in Wales.

1 x 48 - Mouse

ORDER CODE: BRMXGBMO

## ROMAX® GLUE SOLVENT



A responsible and essential component of a Pest Technicians toolbox, the Romax® Glue Solvent solubilises the non-drying glue. This is ideal for removing insects from the Romax® Glue Boards for identification and cleaning hands or surfaces covered in glue. It is also key in the responsible use of glue boards and traps to release non-target pests quickly.

Please note the use of glue boards is prohibited in Wales.

1 x 50 ml

ORDER CODE: BMOBGLUS



### CUSTOMER PRICING

All product pricing is available on our website. Login to your online account to access by scanning the QR Code or go to: [www.barrettineEnv.co.uk](http://www.barrettineEnv.co.uk)



### DON'T HAVE AN ACCOUNT WITH US YET?

Register for free by scanning the QR Code or go to the 'Register' tab on our website homepage.



### BULK PRICING

Contact us for special larger volume pricing. Our sales team will get back to you promptly to review your request.



# RODENT GLUE BOARDS

## PEST MANAGEMENT ALLIANCE HUMANE USE OF RODENT GLUE BOARDS

### Pest Management Alliance - Code of Best Practice - Humane Use of Rodent Glue Boards

In order to protect public health within high-risk environments, the use of rodent glue boards remains an important route if all other options are considered inappropriate. Although rodent glue boards are not designed to physically harm rodents, their use raises valid concerns and they should only be sold to or used by technicians who have been given adequate training and are competent in the effective and humane use of this technique. The following principles must be followed in order to minimise animal welfare concerns:

All interventions aimed at the removal of rodents, including the use of rodent glue boards, have the potential to harm non-target animals and the environment. Although following best practice can mitigate these risks, they cannot be entirely avoided. Therefore, the principal strategy when choosing methods for the control of rodents is to employ the method or methods that have the least potential for adverse impact (i.e. are the least severe and least likely to catch non target animals) but which will be effective in the prevailing circumstances. This is the concept of "risk hierarchy". For more information see the CRRU Code of Best Practice via [www.thinkwildlife.org](http://www.thinkwildlife.org)

The definition of a rodent glue board is "any adhesive coated surface used to catch rodents"

#### 1. Consider the risk hierarchy

All other options for rodent control must be carefully considered before rodent glue boards are used. Detailed records must show why other control methods are either considered inappropriate or have failed. Where there is a rodent in a high risk environment, it may be appropriate for rodent glue boards to be placed strategically to ensure immediate control. Use of rodent glue boards should be based on individual risk assessment, but their use should be reviewed every 24 hours.

#### 2. Trained and competent user

Those selecting the use of or using rodent glue boards for rodent control should be trained and competent in their use. This normally means a relevant certification/qualification and familiarity with the Code of Best Practice for their use.

#### 3. Check rodent glue boards frequently

Where rodent glue boards are used these must be inspected at appropriate intervals. This should be within 12 hours of placing, or at least as soon as is reasonably practicable, including weekends and bank holidays. The pest controller may train one or more on-site personnel to check the rodent glue boards at more frequent intervals in order to minimise the rodents' time spent on traps and/or free non-target species, but it remains the responsibility of the pest controller (under the Animal Welfare Act 2006) to deal with any animals trapped on the rodent glue boards, and to revisit at a minimum of every 12 hours.

If unavoidable events cause slight extensions to inspection intervals then the reasons should be recorded. Longer delays must be avoided (see contingency plan below). Where possible and practical, inspection times must be organised to minimise the time rodents are likely to be on the rodent glue board (e.g. if rodents are known to be active during certain periods, inspection times should be arranged with this in mind). The Animal Welfare Act 2006 requires that caught animals must not display any signs of undue suffering, therefore inspections times should be as frequent as necessary to mitigate against this. Records must be updated after all inspections

#### 4. Have a contingency plan

A contingency plan must be in place so that in the event of an emergency a second competent person can be called upon to inspect the rodent glue boards and deal with any captures or safely remove the rodent glue boards as appropriate. Where it is known rodent glue boards will not be inspected at appropriate intervals they must be taken up (even if only temporarily).

#### 5. Use the correct size rodent glue board for the pest species

The size of rodent glue board must be appropriate for the target species.

#### 6. Detailed records

Detailed copies of records and location plans should be available on site at all times for all rodent glue boards laid during any treatment and must be updated as necessary to ensure traceability. Copies ensure information is available should site records be lost or unavailable.

#### 7. Dispatch of trapped rodents humanely

Rodents trapped on rodent glue boards must be dispatched quickly and humanely by technicians with appropriate training in methods of dispatch. Drowning is not an acceptable method of dispatch.

#### 8. Protect non-target animals

Rodent glue boards must be placed in such a manner that they do not present a risk to non-target species. In the event that a non-target animal is trapped, a freeing agent (a suitable food grade oil or similar emollient) should be applied to the animal for removal. If the trapped animal is injured in such a way that release would result in unnecessary suffering, it should be killed humanely. Non-targets should only be released at their site of capture, not elsewhere, and only if they appear to be physically unharmed and their release is not prohibited by law. Ensure when using rodent glue boards that a suitable emollient is available to hand.

#### 9. Remove rodent glue boards at the end of treatment

At the end of treatment all rodent glue boards must be accounted for, removed by the technician and the records endorsed accordingly.

#### 10. Dispose of rodent glue boards safely

Rodent glue boards should be disposed of with care. The sticky surface must be covered to avoid the accidental trapping of any species or subsequent misuse, and the rodent glue board should be disposed of safely and discretely in accordance with legal waste requirements.

#### 11. Communication with the customer

This Code of Best Practice must be provided to the customer to make them aware of the standards to which the operative is working.

The humane use of rodent glue boards is the legal responsibility of the pest controller, and cannot be delegated to untrained people. All technicians must be suitably trained and competent in their application, maintenance and ultimate disposal including the dispatch of the target species and safe removal of non-target species.

This Code of Best Practice was produced after consultation with Defra, APHA, and Natural England.

The Pest Management Alliance consists of the British Pest Control Association, the Chartered Institute of Environmental Health, and the National Pest Technicians Association.

Credit: The Pest Management Alliance  
<https://www.pmalliance.org.uk/>

REVISED VERSION: JAN 2017

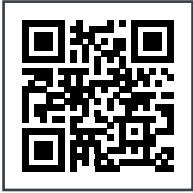

LOGIN TO OUR  
WEBSITE FOR PRICES  
OR REGISTER NOW

# DRAINAGE SYSTEMS

## RATWALL



Ratwall is a robust, well-engineered, highly effective stainless steel rodent exclusion unit for installation within a drainage / pipe system. External Hinge & Pipe Stop. 100% Stainless Steel. Compressible Side Walls.

Ratwall - 110mm	ORDER CODE: BRATWAL
Ratwall - 150mm	ORDER CODE: BRAT150
RATWALL INSTALLATION POLE	
Each	ORDER CODE: BRAT151

## RODENT control

PRODUCTS

## HYGIENE & DISINFECTANTS

**NEW**

### KNOCKOUT® MAX STRENGTH DISINFECTANT



An all-purpose, ready-to-use formulation suitable for use on a wide variety of surfaces. Next generation formula proven to kill bacteria, viruses and fungi including Covid-19. Ideal for use in and around domestic premises, kennels and other sensitive areas. Kills 99.9% of bacteria and viruses, including: *Bactericidal, Yeasticidal, Bactericidal + Yeasticidal, Fungicidal, Full Virucidal + SARS-CoV 2, Salmonella, Listeria and Campylobactor.*

1 x 1 Litre	ORDER CODE: BKOODI01
-------------	----------------------

### KNOCKOUT® MOULD & MILDEW CLEANER



A ready to use surface fungicidal wash containing biocides for the control of organic growths and spores, with a cleaning action to remove light dirt. Can be used externally and internally to eliminate mould, mildew, algae and fungi from masonry, timber, plastic and similar substrates. Leaves the surface clean for further remedial treatment.

Each	ORDER CODE: BKOMM004
------	----------------------



# PAPERWORK & LABELS



LOGIN TO OUR WEBSITE FOR PRICES OR REGISTER NOW

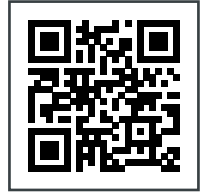

## TREATMENT REPORT PADS



A two part A5 NCR treatment report pads. Each pad consists of 75 reports.

Each - A5

ORDER CODE: BTREAPAD

## ROMAX® MOUSE BOX DATE LABELS

Date sticker designed to fit inside the Romax® mouse box (and other brands). Allows up to 20 dates and allows the operator to tick which 'active' is in use in the box. Made from vinyl weather-resistant material.



1 x 100

ORDER CODE: BROINSMO

## EXTERNAL BAIT BOX POINT LABELS

Vinyl weather-resistant bait point label. For use with any baiting point.



1 x 100

ORDER CODE: BROINSLA

## BAIT BOX INFORMATION LABELS

Anticoagulant rodenticides refer to a requirement for labelling bait stations with specific information. To make life simpler for pest controllers, Barretine has produced a new 'Box Information Label'. This label contains the required information and can be affixed to the outside of mouse and rat bait stations. The sticker is waterproof, resistant to UV-light and can be written on with a permanent marker pen or ballpoint pen.



1 x 100

ORDER CODE: BBOXLAB1



INSECT CONTROL

# INSECT control

PRODUCTS 

PEST CONTROL CATALOGUE 2024/2025

# PESTICIDE FREE



LOGIN TO OUR WEBSITE FOR PRICES

OR REGISTER NOW

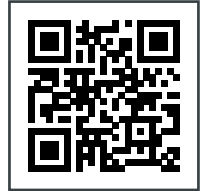

## OA2KI® CONCENTRATE



Oa2Ki® Concentrate is a novel polymer technology formulation combined with a water-based delivery system and functions solely by physical means as a liquid sticky trap. Oa2ki® is pesticide-free and is effective in suppressing most types of common flying and crawling insects such as ants, cockroaches, flies, fleas, wasps, and stored product insects.



1 x 500 ml

ORDER CODE: BOA2KI.5

6 x 500 ml

ORDER CODE: BOA2KIBP

## OA2KI® POWDER



Oa2Ki powder is produced from fossilised diatoms (Diatomaceous Earth). The powder is able to desiccate most areas where it is applied. Oa2Ki powder can be applied as dust up to 10 to 30 g/ m<sup>2</sup> of hard surface. Do not breathe powder and wear a mask (P2 filter DIN EN 143).  
• 400 g Puffer Pack • 4 Kg Bucket • 25 Kg Bag.



1 x 400 g

ORDER CODE: BDIAM500

1 x 4 Kg

ORDER CODE: BDIAM4KG

1 x 25 Kg

ORDER CODE: BDIAM020

## OA2KI® READY TO USE



Oa2ki® Ready to Use is the ideal product to use or leave behind with your customer as a backup. For example, if you've just treated for ants, fleas or bed bugs, you can leave this behind so the customer can suppress any stragglers that are still appearing, thus reducing call-backs.



6 x 500 ml

ORDER CODE: BOA2KITRI

## OA2KI® AEROSOL (SILICON DIOXIDE)



Very effective in controlling insects by desiccation- apply a light dust to cracks and crevices to insect harbourage areas. Ideal for direct spray application onto vertical surfaces, and under the bed and in crevices where bedbugs are harbouring.

1 x 500 ml

ORDER CODE: BOA2KIAR

ANTS



FLEAS



BED BUGS



FLIES



# Oa2ki®

IMPROVED FORMULA

## FAST KNOCKDOWN FOR CRAWLING & FLYING INSECTS

Available in three formulations

Product attributes vary within the Oa2ki® brand.  
Please read the label for scope and usage.

FOR USE WITHIN  
KITCHENS



FOR USE WITHIN  
BEDROOMS & BEDS



FOR USE WITHIN  
BATHROOMS



FOR USE WITHIN  
CRACKS & CREVICES



**Barrettine**  
Environmental Health

USE BIOCIDES SAFELY. ALWAYS READ THE LABEL  
AND PRODUCT INFORMATION BEFORE USE.

Unit 4 Caxton Business Park, Crown Way, Warmley, Bristol BS30 8XJ.  
Tel: 0117 967 2222 Email: beh@barrettine.co.uk www.barrettineEnv.co.uk



# PESTICIDE FREE



LOGIN TO OUR WEBSITE FOR PRICES

OR REGISTER NOW

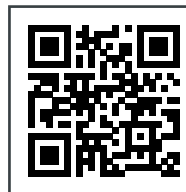

## FLYMAX® ULV



Flymax® ULV provides rapid insect knockdown against flies, moths and crawling insects. Flymax® ULV is a ready-to-use cellulose formulation combined within a water-solvent based delivery system. An ideal flying and crawling insect adulticide against insecticide resistant insect strains having the added benefit of being insecticide free with no residual activity and no maximum treatment frequency. Flymax® ULV is for professional use in lofts, homes, agricultural buildings in and around domestic properties, public and municipal areas, refuse tips, poultry houses, slaughterhouses and manure heaps.



1 x 1 Lire

ORDER CODE: BFLYMAXU

## MITEMAX®



MiteMax® is highly effective against poultry red mite (*Dermanyssus gallinae*). MiteMax® is a patented formulation that has been optimised to penetrate the dusty layers typically found within hen houses and grain stores to spread deep into the cracks and crevices that harbour mites.

MiteMax® contains an advanced food-grade cellulose polymer that acts on-contact with the mite. MiteMax® functions as a sticky trap rendering mites irreversibly immobile providing rapid knockdown. MiteMax® has a physical mode of action by trapping and the death/ killing effect is the consequence of this, which means it both falls outside the scope of the biocide directive (exempted from EU Reg. 528/2013) and also is effective against mites resistant to chemical insecticides.

6 x 500 ml

ORDER CODE: BMITE500M



Patented Technology: EP 3319422

### Fast Knockdown Mite Treatment



MiteMax® is highly effective against poultry red mite (*Dermanyssus gallinae*). MiteMax® is a patent pending formulation that has been optimised to penetrate the dusty layers typically found within hen houses to spread deep into the cracks and crevices that harbour mites.

- ✓ **FAST KNOCKDOWN OF POUALTRY RED MITE**
- ✓ **DUST PENETRATING FORMULATION**
- ✓ **EFFECTIVE ON SPECIES RESISTANT TO CHEMICAL INSECTICIDES**

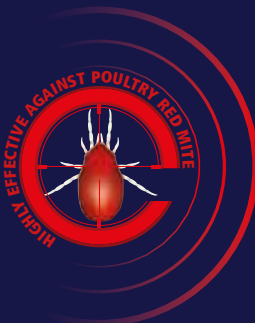

**Barrettine**  
Environmental Health





## URBAN & AGRICULTURAL RAPID INSECT KNOCKDOWN

Insecticide resistant formulation

Rapid adulticide knockdown

Rapid re-entry time

Ideal for sensitive application areas

## INSECTICIDE FREE

READY-TO-USE, CELLULOSE FORMULATION

PATENTED TECHNOLOGY: EP 3319422

## RAPID INSECT KNOCKDOWN THROUGH INSECT ENCAPSULATION AGAINST FLIES, MOTHS & CRAWLING INSECTS

Flymax® ULV provides rapid insect knockdown against flies, moths and crawling insects. Flymax® ULV is a cellulose formulation combined within a water-solvent based delivery system. An ideal, ready-to-use flying and crawling insect adulticide against insecticide resistant insect strains having the added benefit of being insecticide free with no residual activity and no maximum treatment frequency. Flymax® ULV is for professional use in lofts, homes, agricultural buildings in and around domestic properties, public and municipal areas, refuse tips, poultry houses, slaughterhouses and manure heaps.

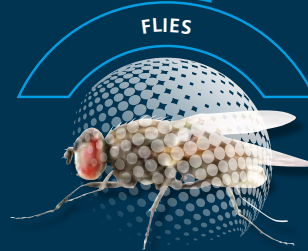

FLIES

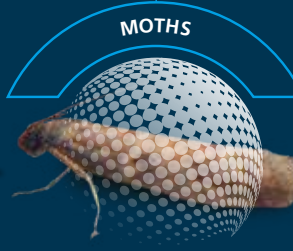

MOTHS



CRAWLING INSECTS

Barretline Environmental Health  
Unit 4 Caxton Business Park, Crown Way, Warmley, Bristol BS30 8XJ.  
T: +44 (0) 117 967 2222 E: beh@barretline.co.uk  
www.barretlineEnv.co.uk



# MoBe<sup>®</sup> ant GEL BAIT

Dosage rates per 35g tube

Over 100  
Applications  
from a  
35g Tube



- Neutralises the source of infestation
- Approved for use against tropical ants
- Effective against larvae due to feeding behaviour

## Highly Attractive Bait Matrix

MoBe Ant gel is an effective method of controlling both native and tropical species of ants both indoors and around buildings. The gel bait is composed of highly desirable sugars designed to exploit the social behaviour of the insects and eradicate the nest.

MoBe Ant gel is effective against all life stages and colony members, most importantly the queen. The gel can be applied directly along foraging trails or in a feeding station to encourage uptake.



**Barrettine**  
Environmental Health

For all sales enquiries please contact:  
T: +44 (0) 117 967 2222 E: beh@barrettine.co.uk  
[www.barrettineEnv.co.uk](http://www.barrettineEnv.co.uk)

Use Biocides Safely, always read the label and product information before use.



## Dosage rates per 35g tube

350 Doses  
per tube for a  
Standard Treatment

175 Doses  
per tube for a  
Heavy Treatment



# MoBe<sup>®</sup> roach GEL BAIT

• Quick and precise delivery

• Knock-on effect for fast control

• More effective on adult cockroaches than Fipronil\*

## Highly Attractive Bait Matrix

MoBe Roach Gel is effective against all life stages of both German and Oriental Cockroaches and suitable to be applied directly to their harborage areas, minimizing risk of exposure to non-target species and humans.

Effective control is achieved through exploiting the natural habits of the cockroach, allowing the active to transfer between individuals inhabiting the same area – even if they do not directly ingest the bait.

*\*Imidacloprid shown to provide more effective control of adult cockroaches than fipronil in field studies (91.17% - Imidacloprid vs 59.33% - Fipronil)*

(Abdullah, N. and Majid, A., 2022)



For all sales enquiries please contact:  
T: +44 (0) 117 967 2222 E: beh@barrettine.co.uk  
www.barrettineEnv.co.uk

**Barrettine**  
Environmental Health

Use Biocides Safely, always read the label and product information before use.



# ANT & COCKROACH BAIT

**NEW**

## MoBe<sup>®</sup> ANT GEL BAIT



MoBe Ant gel is an effective method of controlling both native and invasive species of ants both indoors and around buildings. The gel bait is composed of highly desirable sugars designed to exploit the social behaviour of the insects and eradicate the nest.

MoBe Ant gel is effective against all life stages and colony members, most importantly the queen. The gel can be applied directly along foraging trails or in a feeding station to encourage uptake.

Gel canteen sold separately, see bottom of page.

4 x 35 g

ORDER CODE: BMOBAG30

**NEW**

## MoBe<sup>®</sup> COCKROACH GEL BAIT



MoBe Roach Gel is effective against all life stages of both German and Oriental Cockroaches and suitable to be applied directly to their harborage areas, minimizing risk of exposure to non-target species and humans.

Effective control is achieved through exploiting the natural habits of the cockroach, allowing the active to transfer between individuals inhabiting the same area - even if they do not directly ingest the bait.

Gel canteen sold separately, see bottom of page.

4 x 35 g

ORDER CODE: BMOBRG30

## GEL CANTEEN



Can be quickly filled with gel baits through the small hole on the top of the station the gel canteen is suitable for applying cockroach and ant gels. The entire station rotates, allowing the user to restrict the size of the opening dependent on species (and prolong the bait life) and completely close the aperture. Please note these stations are supplied empty and are used in conjunction with insecticide baits and gels.

1 x 30

ORDER CODE: BINSGELC

## BIOPREN BMS



Containing the insect growth regulator S-Methoprene (0.5 %). Biopren BMS acts by preventing reproduction and blocking growth of larvae in Pharaoh's ant colonies. This granular bait formulation is contained in a ready-to-use container with a food attractant, which can simply be cut open and stuck to a suitable surface.

12 x 2.5 g

ORDER CODE: BBIOPBMS



# BED BUG, ANT & COCKROACH TRAPS

**NEW**

## MoBe<sup>®</sup> ANT STATION



Mobe Ant Station, containing Imidacloprid (0.01% w/w) offers long term control within its highly palatable bait matrix. Target control is achieved by elimination of the queen, workers and larvae. Its ready to use, discreet and durable design ensures easy placement in areas of high ant activity, making it an ideal choice for both indoor and outdoor use, including lawns. MoBe Ant station is highly effective against Black Ants, Pharaoh Ants and Argentine Ants.

Approved for Amateur and Professional Use

15 x 1.4 g

ORDER CODE: BMOBANTS

# MoBe<sup>®</sup> ant STATION

### Add Convenience, Reduce Callbacks

Approved for Amateur and Professional Use

- ✓ Long term control
- ✓ Highly palatable bait matrix
- ✓ Effective against **Black Ants, Pharaoh Ants and Argentine Ants**
- ✓ Targeted control of the ant colony for elimination of the **queen, workers and larvae**



USE BIOCIDES SAFELY. ALWAYS READ THE LABEL AND PRODUCT INFORMATION BEFORE USE.

## TRAPPIT BB DETECTOR & DETECTOR PLUS



Agrisense have developed and refined a formulation that has resulted in a trap that is both sensitive and efficient in trapping and monitoring both the instar developmental stages as well as adult Bed Bugs. The trap allows effective and discreet monitoring of the presence of Bed Bugs, and when used with the lure the catch rate is greatly improved.

The Agrisense bed bug lure significantly improves the catch rate when used with the trap. Excellent detection of Bed Bug nymphs.

2 x 10  
without lure

ORDER CODE: BTRBBMON

2 x 10  
with lure

ORDER CODE: BTRBBLUR

# INSECT TRAPS



LOGIN TO OUR  
WEBSITE FOR PRICES

OR REGISTER NOW

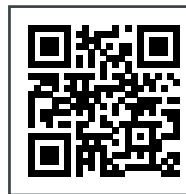

## MoBe® MOAT



MoBe® Moat has been designed and successfully used by professional pest controllers in conjunction with some of the industries leading food manufacturers.

The MoBe® Moat consists of 18 metres of siliconised paper with adhesive applied to one surface and has been manufactured as an aid to trapping insects around problem, high risk areas. The strip is wide enough to act as a barrier to help prevent insects from crossing over. The paper comes with pre-printed hazard warning lines so to warn others of the tape as well as usage instructions. The tape can be cut to the desired length giving a great number of potential applications. If trapping/monitoring insect pests, additional lures can be added along the tape's length.

Primarily the MoBe® Moat has been designed as a 'quarantine' barrier working in two ways:

- To stop potential movement by pests into previously infestation-free areas/products
- To cordon off known infested areas or products to prevent the spread of an infestation.

Some of the many potential applications:

- 1) To quarantine contaminated pallets of product and prevent cross-contamination to other stock, e.g. peanuts, rice, pet food.
- 2) To act as a barrier to known clean products, e.g. post fumigation commodities or finished product awaiting dispatch.
- 3) Using tape to glue the underside, MoBe® Moat can be stuck to the inside of silos to prevent migration of grain pests.
- 4) Act as a single large overnight trap in sensitive infested areas, e.g. around the perimeter of commercial kitchens against cockroaches.

Please be aware the start of the roll contains no glue.

Standard outer 15

Please note that whilst the glue has been designed and tested successfully against insects, as with other similar devices, we cannot guarantee that it will successfully retain all pests under all environments and conditions. The MoBe® Moat is sold as a professional only product.

1 x 18 m

ORDER CODE: BMOBMOAT

## ROMAX® INSECT 'FLOOR' CLEAR & BLACK

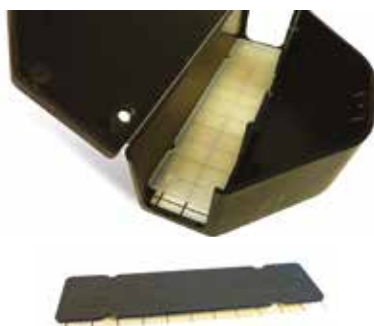

An insert to convert the award-winning Romax® mouse box, into a convenient and cost-effective insect monitor. The clear design allows easy identification at a glance to determine if there are any (larger) insects on the pad below.

1 x 10  
Clear

ORDER CODE: BBBROMFC

1 x 10  
Black

ORDER CODE: BBBROMFL

## MoBe® ROACH TRAP



The MoBe roach trap is an effective, low profile, monitoring trap that can be placed under shelving and into restricted spaces which can be used before, during, and after treatment of cockroach infestations to locate problem areas of harbourage, allowing pest controllers to focus their efforts in specific areas. The MoBe roach traps have a high capacity to detect low-level populations and can also be used in a wide variety of environments, including the food industry, as part of an integrated pest management programme. The traps are a safe and non-toxic way to identify cockroaches of all species.

**Benefits:**

- Ready to use
- Glue board with integrated attractant lure
- Non-toxic monitoring
- Low profile for effective placement

1 x 10

ORDER CODE: BMOBECRT

# MoBe<sup>®</sup> Moat

## A Multi-purpose Adhesive Barrier

For temporary quarantine, pest monitoring and product protection.

Protects against  
Crawling Insects



### KEY FEATURES:

- /// Isolate suspected and infested products.
- /// Ideal for use as a temporary monitor trap & entry barrier.
- /// Chemical free protection for food storage, production & handling materials.
- /// Special non-dry glue technology - stays sticky for long periods.
- /// 18 metres on every roll - special siliconised paper.
- /// Easy to tape down for greater security.



● Attach food or pheromone lures to attract target pests.



● MoBe Moat can be cut to fit any situation.



# WASP TRAPS & BAIT

## TRAPPIT WASP BAG



Effective, safe and easy to use. Each trap has a generic print, with instructions for use in six languages. For the wasp bag, use 500 ml of ready to use wasp bait (sold separately, see below) and hang. Once the trap is full of dead insects, close the screw cap and dispose of in household waste.

Standard outer 25

Each

ORDER CODE: BTRWASPB

## TRAPPIT LIQUID WASP BAIT



Just add water: a single trap can catch and kill up to 20,000 flies. For outdoor use, ideal for farms, stables, gardens and around bins and refuse areas. Clean and easy disposal.

Standard outer 2

1 x 5 Litre

ORDER CODE: BTRDWFL5

## VESPULURE WASP BAIT



A highly effective monitoring liquid to be placed within wasp monitoring traps to monitor the presence of wasps and hornets, including Asian hornets (*Vespa velutina*). The use of the Vespulure monitoring liquid can draw wasps away from areas and can also be used as an effective feeding station to identify the location of wasp and hornet nests for areas that subsequently, need to be cleared of these stinging insects.

The monitoring liquid is formulated with carbohydrates and volatile solvents that assist in expanding of the monitoring area. The formulation contains a bee repellent.

1 x 5 Litre

ORDER CODE: BVESPUL5

# Whilst you are here... Follow us on Facebook!

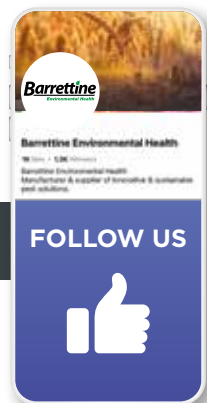

Keep up to date with our latest products and deals!



GROWING COMMUNITY



EXPLORE OUR WEEKLY POSTS



LATEST PRODUCTS & PROMOTIONS

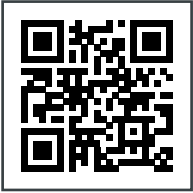

# PHEROMONE TRAPS

## GENERAL GRAIN BEETLE ATTRACTANT



The lure has been formulated to be particularly effective in attracting: *Sitophilus granarius* (grain weevil, wheat weevil, or granary weevil) a serious pest of oats wheat, barley, rye, corn and rice. *Sitophilus oryzae* (lesser grain weevil or rice weevil) pests of stored cereals such as barley, maize, rice and wheat, split peas and pasta. *Oryzaephilus surinamensis* (saw-toothed grain beetle) a pest of damaged cereal grains.

1 x 10

ORDER CODE: BGRBTATT

## ENTRAP - GRAIN STORE INSECT MONITOR



For use in empty grain stores to monitor insect levels. Easy to assemble sticky trap with luring agent - lure contains no grain or nuts.

1 x 4 Traps & Lures

ORDER CODE: BENTRAPS

## CL TRAC PRE-BAITED CLOTHES MOTH & HOLDER



CL-Trac Clothes moth holder and lure - Highly effective monitoring of clothes moth infestations and necessary when natural materials such as woollen clothing, upholstery and carpets, as well as other animal-based material, such as silk, hair or fur need to be monitored. Pheromone lure has an optimised release rate over a 12 week duration.

CLOTHES MOTH KIT (10 holders and lures)

1 x 10

ORDER CODE: BLPBCLOT

REPLACEMENT LURE PADS (10 glue pads and pheromone lure)

1 x 10

ORDER CODE: BLPBLURE

## LURES



Other lures available are on request including Lesser Grain Borer, Carpet Beetle. Call the sales office for details. Minimum order quantity may be required. All pack sizes: 1 x 10

PRODUCT

ORDER CODE

Stored Product Moth  
*Ephestia / Plodia*

BLEPPLD

# INSECT PHEROMONES & LURES

## AMENITY MOTH LURES



The Pine Processionary (*Thaumetopoea pityocampa*) is a moth of the family *Thaumetopoeidae*. It is an abundant species of pine woods in central and southern Europe, and as such, has been an important economic pest to Forestry. This is increasing concern, especially in more urban areas due to both the severely irritating hairs that protect the caterpillar larvae. The Oak Processionary Moth is an invasive pest relatively new to England, being found in London in 2006. The Oak processionary Moth is a serious health risk to humans and animals, predominantly from the urticating hairs that cause allergic responses and necrosis on the tongues of dogs that come into direct contact with the caterpillars.

Lures and traps are available to monitor Pine and Oak Processionary Moths in high risk areas. In addition, a number of treatment options are available for both Processionary and Brown Tail Moths, contact the office for more information.

1 x 10

ORDER CODE: BLPINEML

## TRAPS & LURE USAGE



WEEVIL	COMMON NAME	MOBE TRAP	GENERAL GRAIN BEETLE ATTRACTANT	CL TRAC
<i>Sitophilus granarius</i>	Grain Weevil/Wheat Weevil		■	
<i>Sitophilus oryzae</i>	Lesser Grain Weevil/Rice Weevil		■	
MOTH	COMMON NAME			
<i>Ephestia elutella</i>	Warehouse/Tobacco Moth	■		
<i>Tineola bisselliella</i>	Clothes Moth			■
BETLES	COMMON NAME			
* <i>Lasioderma serricorne</i>	Tobacco Beetle	■		
<i>Oryzaephilus surinamensis</i>	Sawtooth Grain Beetle		■	

\* Also consider *Serrico* traps.

### BESPOKE COMPANY ONLINE ORDERING FACILITY

It's time to simplify handling the needs of your employees.

Whether it's selecting stock from a pre-approved product list or reporting on stock levels held by your technicians, we've got you covered. Ordering supplies from us is simple for you and your staff. All order requests can be tailored for management approval before dispatch. We can create a custom ordering process designed just for your business. Once approved, your order is sent to our sales team for immediate dispatch.

>> Save time >> Save money >> Streamline your process!

Contact our team and enquire today.



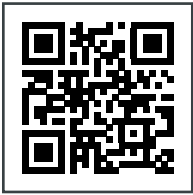

# TOBACCO BEETLE & MOTH TRAPS

## MoBe® COMBO TRAP Mk.2



The MoBe® Combo Trap Mk.2 monitoring system has been designed specifically for the Tobacco Industry and is based on the latest in pheromone technology. The MoBe® lure is a combined lure that contains the sex pheromone for both the tobacco beetle (*Lasioderma serricorne*) and tobacco moth (*Ephestia elutella*) thus reducing both product and labour costs.

Standard outer 10

1 x 20 Traps

ORDER CODE: BTRMOBET

## SERRICO TRAPS



Folded carton board trap lined with contact adhesive. Attracts Tobacco Beetle through placement on the trap of a food attractant and the Female Sex Pheromone. Each pack contains 10 traps, Pheromone/Food Lures. (One year shelf life).

Standard outer 20

1 x 10

ORDER CODE: BTRSERIC

### MoBe® Combo

### Mk. 2 Trap

TOBACCO  
PEST CONTROL

## INSECT MONITORING

PROTECT YOUR INVESTMENT, YOUR PROFIT, YOUR REPUTATION!

The MoBe® Combo Mk.2 tobacco monitoring trap is an essential component in the quality management of your tobacco product. Early assessment of any potential infestation of the two key insect pests of stored tobacco is vital.

**EFFECTIVE FOR THE:**

- Early detection of insect pests within the tobacco industry.
- Post treatment assessment of control measures.

**APPROVED FOR USE IN:**

- Tobacco storage facilities and warehouses.
- Tobacco supply chain and shipping containers.
- Tobacco manufacturing facilities.
- End user applications where tobacco products are stored.

INSECT CONTROL - TOBACCO BEETLE & MOTH TRAPS



# INSECTICIDE CONCENTRATES

# INSECT control

PRODUCTS

INSECT CONTROL - INSECTICIDE CONCENTRATES

## ALPHA SCT®



Combining the synergy of two pyrethroid molecules (10 % (w/w) Cypermethrin & 0.9 % (w/w) Tetramethrin), Alpha SCT offers the knockdown effectiveness of Tetramethrin and the well-known residual characteristics of Cypermethrin into a single product giving effective control of both flying and crawling insects. For use on flies, moths, red poultry mite, beetles, fleas, ticks, bed bugs, cockroaches, crickets, silverfish, booklice, mites, ants, mosquitoes, wasps and centipedes. For use in and around domestic properties, public and municipal areas, refuse tips, poultry houses, slaughterhouses and manure heaps.

1 x 500 ml

ORDER CODE: BALPSCTA

## CIMETROL SUPER EW



Contains Cypermethrin 25% w/w, Tetramethrin 10% w/w, Piperonyl Butoxide 20% w/w & Pyriproxyfen 1% w/w. Cimetrool Super EW is the next generation of product for the control of insect pests (not spiders). Formulated as an oil-in-water emulsion containing a very high loading of active ingredient, it allows rapid access of the active ingredient to the insect while providing long-lasting and predictable residual control.

1 x 500 ml

ORDER CODE: BCIMESUP

## AQUAPY®

IR



Contains 30 g / litre of pyrethrins synergised with 150 g / litre Piperonyl Butoxide. Aquapy is a water-based formulation ideal for space treatments against flies, mosquitoes, moths, tobacco beetles on the wing and other stored product insects. Accepted for Use in Organic areas/sites. (Requires PA1 and PA9 certificate for fogging grain stores and agricultural applications). IR (93571) Standard outer 12

1 x 1 Litre

ORDER CODE: BAQUA001



### CUSTOMER PRICING

All product pricing is available on our website. Login to your online account to access by scanning the QR Code or go to: [www.barrettineEnv.co.uk](http://www.barrettineEnv.co.uk)



### DON'T HAVE AN ACCOUNT WITH US YET?

Register for free by scanning the QR Code or go to the 'Register' tab on our website homepage.



### BULK PRICING

Contact us for special larger volume pricing. Our sales team will get back to you promptly to review your request.



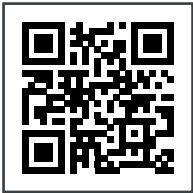

# INSECTICIDE CONCENTRATES

## BIOPREN 6 EC



A highly effective formulation containing the insect growth regulator s-methoprene 6.74 % (w/w), as well as a flushing agent and knock-down insecticide pyrethrins 4.81 % (w/w). Suitable for both bed bugs and fleas.

1 x 500 ml

ORDER CODE: BBIOPREC

## PERMOST UNI FLY SPRAY



An effective ready to use surface and space treatment (Fog or ULV) for flying and crawling insects offering rapid knockdown. For use against flies, mosquitoes, moths, wasps, ants, cockroaches, earwigs, bristletails, fleas, beetles, mites, ticks and lice. Contains Permethrin and Tetramethrin with Piperonyl Butoxide as a synergist.

For application as space or surface treatment to hard porous and non-porous surfaces. Space treatment: applied through a fogging machine at a rate of 1 ml of product per cubic metre.

Surface treatment: applied through a hand sprayer or boom and nozzle sprayer apparatus as a medium or coarse spray. An application rate of 10 ml/ m<sup>2</sup>.

1 x 5 Litre

ORDER CODE: BPERTU

## TECHNICIANS FIELD GUIDE

A complete and essential guide for the professional.

- FLYING INSECTS
- CRAWLING INSECTS
- RODENT PESTS
- BIRD PESTS
- SPI, AGRICULTURE & AMENITY PESTS

The Barretts' pocket-size A6 Pest Technicians guide contains detailed information to assist in the daily routine of a Professional Pest Control Operator. A 'how to' guide covering topics of insect and rodent information and identification, equipment calibration, non-chemical insect control measures, pesticide application and product safety, dealing with waste: Triple rinsing as well as detailed information on LD<sub>50</sub>.

ORDER CODE: BPIDBOOK



INSECT CONTROL - INSECTICIDE CONCENTRATES

# DUST & WETTABLE POWDER



LOGIN TO OUR WEBSITE FOR PRICES OR REGISTER NOW

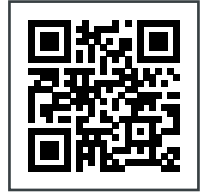

## CYTROL FORTE WP SACHETS



Contains 40 % (w/w) Cypermethrin. Available in handy 10g soluble sachets. The product can be applied by a standard compression sprayer. Standard outer 6

10 x 10 g Sachets

ORDER CODE: BCYTRFOR

## VULCAN P5



Formulated as a dust for use in voids or around electrical installations where liquid sprays may not be appropriate. For the general control of crawling or resting insects, it can be applied by hand or powered dusters and offers excellent wasp control.

1 x 4 Kg

ORDER CODE: BVULDP4K

## DECIS PROTECH INSECTICIDE



Decis Protech is a non-systemic insecticide which acts by contact and ingestion to sucking and chewing insects. Its high lipophilicity provides a high affinity with the insect cuticle.

Active ingredient contains a broad-spectrum pyrethroid (15 g/l Deltamethrin) for control of aphids, caterpillars and other pests in agricultural, horticultural crops and amenity areas.

1 x 1 Litre

ORDER CODE: BDECIS1L



### CUSTOMER PRICING

All product pricing is available on our website. Login to your online account to access by scanning the QR Code or go to: [www.barrettineEnv.co.uk](http://www.barrettineEnv.co.uk)



### DON'T HAVE AN ACCOUNT WITH US YET?

Register for free by scanning the QR Code or go to the 'Register' tab on our website homepage.



### BULK PRICING

Contact us for special larger volume pricing. Our sales team will get back to you promptly to review your request.



# ALPHA SCT

## Pyrethroid Insecticide CONCENTRATE

Insecticide for professional use against crawling and flying insects.

Contains:  
Cypermethrin 10 %,  
Tetramethrin 0.9 %

Insecticide for professional use against crawling and flying insects such as: Flies, Moths, Beetles, Fleas, Ticks, Bed Bugs, Cockroaches, Crickets, Silverfish, Booklice, Mites, Ants, Mosquitoes, Wasps and Centipedes. For use in and around domestic properties, public and municipal areas, refuse tips, poultry houses, slaughter houses and manure heaps (12 week residual).

**Application:** Remove cap from dosing chamber on bottle. Squeeze bottle to fill dosing chamber. Add to 5 litres of clean water and mix well. Apply according to Statutory Conditions as a coarse spray.

USE BIOCIDES SAFELY. ALWAYS READ THE LABEL AND PRODUCT INFORMATION BEFORE USE.



Bed Bugs



Ants



Cockroaches



Stored Product Insects



Flying Insects



**Barrettine**  
Environmental Health

Unit 4 Caxton Business Park, Crown Way,  
Warmley, Bristol BS30 8XJ.  
T: 0117 967 2222 E: beh@barrettine.co.uk  
[www.barrettineEnv.co.uk](http://www.barrettineEnv.co.uk)



# SMOKE GENERATORS & AEROSOLS



LOGIN TO OUR WEBSITE FOR PRICES

OR REGISTER NOW

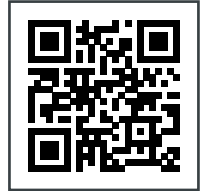

**NEW**

## FORTEFOG P FUMERS

IR



Contains: 13.25% w/w permethrin. Fortefog P permethrin fumers are simple to use in the home or office and are effective against a wide range of flying and crawling insects. Fumers are particularly useful in situations where spraying access is difficult or limited.

Area of coverage: Mini Fumer 120m<sup>3</sup>, Maxi Fumer 1000m<sup>3</sup>

Mini Fumer

ORDER CODE: BFORTMIN

Maxi Fumer

ORDER CODE: BFORTFUM

## FLYING INSECT KILLER



Flying Insect Killer contains D-Tetramethrin 0.15 % (w/w) and D-Phenothrin 0.15 % (w/w) for Flying insect control. Can also be used for controlling ants, bed bugs, cockroaches and fleas.

12 x 400 ml

ORDER CODE: BPRCOFLY

## CIMETROL SUPER RFU



Cimetro Super RFU is a professional ready for use, water-based spray to control bedbugs, fleas and other crawling and flying insects. Approved for use on mattresses and soft furnishings, the unique 300ml bottle delivers a fine and continuous spray at any angle and even upside down.

Standard outer 12.

1 x 300 ml

ORDER CODE: BCIMERTU

## PROTECTOR 1 SHOT



Contains 0.25 % (w/w) Pyrethrins. Water-based aerosol with special lock nozzle enabling the spray to be used as a full release aerosol. An ideal alternative to smoke generators, e.g. cluster flies in a loft, offering a rapid knockdown.

**Organic option.**

1 x 530 ml

ORDER CODE: BPR1SHEA



**International**

# Not just for bedbugs!

Cimetrol Super's unique blend of active ingredients, including the insect growth regulator pyriproxyfen, delivers rapid and long lasting control of fleas, moths, flies, mosquitos, ticks, mites, ants, beetles, cockroaches and other crawling insects...

*and bedbugs.*



**NEW**  
RFU SPRAY  
BOTTLE

[www.PelGar.co.uk](http://www.PelGar.co.uk)

▶ Rodent Control ▶ Insect Control ▶ Plant Protection ▶ Insect Repellents ▶ Decontamination Kits

Concentrate Contains: cypermethrin 25% w/w, tetramethrin 10% w/w, piperonyl butoxide 20% w/w and pyriproxyfen 1% w/w.  
Use biocides safely. Always read the label and product information before use.



# RURAL & GRAIN STORE HYGIENE



LOGIN TO OUR WEBSITE FOR PRICES

OR REGISTER NOW

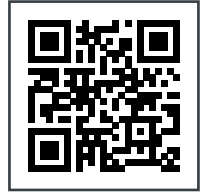

**NEW**

## CROP PROTECT® 25EC



CropProtect® 25EC is the latest addition to the Barrettine family of grain hygiene products. This concentrated product is capable of treating one tonne of grain with just 10ml (diluted in one litre of water) and providing you with long-lasting protection for up to a year.

CropProtect® 25EC is designed to be applied to the interior of grain storage facilities to eliminate any pests remaining from previous issues or applied directly to the grain post-harvesting to ensure long-lasting defence against infestation.

MAPP: 20530

1 x 1 Litre

ORDER CODE: BCROPPRO-1

## FLYMAX® ULV

IR



Flymax® ULV provides rapid insect knockdown against flies, moths and crawling insects. Flymax® ULV is a ready-to-use cellulose formulation combined within a water-solvent based delivery system. An ideal flying and crawling insect adulticide against insecticide resistant insect strains having the added benefit of being insecticide free with no residual activity and no maximum treatment frequency. Flymax® ULV is for professional use in lofts, homes, agricultural buildings in and around domestic properties, public and municipal areas, refuse tips, poultry houses, slaughterhouses and manure heaps.

1 x 1 Litre

ORDER CODE: BFLYMAXU

## PYBUTHRIN 33



Contains 0.38 % (w/w) natural pyrethrins synergised with Piperonyl Butoxide. A ready-to-use high volume space spray for the control of flying and crawling insects. It offers rapid knockdown and kill with no residual activity. Pybuthrin 33 can be applied as a coarse spray via a compression sprayer, or as a mist or fog. IR(93411)

Standard outer 4

1 x 5 Litre

ORDER CODE: BPY33005

## X-LARV



X-LARV is an innovative product for the treatment of stagnant and still waters to control mosquito larvae. X-LARV acts by physical-mechanical action ensuring efficacy up to 4 weeks and for use in still and stagnant water such as sewers, drains, manholes, saucers, buckets, tires, gutters, water tanks and septic tanks, etc.

X-LARV is a liquid ready to use which, when applied to the surface of the water, quickly creates a thin film that prevents the development of immature stages of mosquitoes (larvae and pupae).

1 x 1 Litre

ORDER CODE: BXLARVIL



# CROP PROTECT<sup>®</sup> 25EC

## A VERSATILE GRAIN PROTECTANT

Prevents contamination from insects and retains the quality of stored grains.



MAPP 20530

- ✓ Pre-harvest treatment of the building fabric
- ✓ No with-holding period
- ✓ Admixture    ✓ Pyrethroid formulation

CropProtect<sup>®</sup> 25EC is designed to be applied to the interior of grain storage facilities to eliminate any pests remaining from previous issues or applied directly to the grain post harvesting to ensure long-lasting defence against infestation. This concentrated product is capable of treating 50m<sup>2</sup> with just 20-30 ml (diluted in 5 litres of water) and providing you with long lasting protection. CropProtect<sup>®</sup> 25EC may also be applied directly to grain as an admixture.

Thanks to its synergised formulation of deltamethrin and piperonyl butoxide, CropProtect<sup>®</sup> 25EC can eliminate and deter common grain pests such as grain weevils, saw toothed grain beetles, flour beetles and grain borers. Additionally, flying pests such as warehouse and grain moths are effectively controlled.



SCAN ME



**Barrettine**  
Environmental Health

**Barrettine Environmental Health**  
Unit 4 Caxton business Park, Crown Way, Warmley, Bristol. BS30 8TY.  
T: +44 (0) 117 960 0060 E: beh@barrettine.co.uk  
[www.barrettineEnv.co.uk](http://www.barrettineEnv.co.uk)

Use Biocides Safely, always read the label and product information before use.



# WOOD PRESERVATION & TREATMENTS

# INSECT control

PRODUCTS

## CREOSOLVE LIGHT & DARK



For exterior use only. Similar physical/water repellency/application characteristics of traditional Creosote but contains no biocide/preserver. A bitumen/ wax-based treatment that helps to protect exterior rougher cut timber by repelling water and preventing ingress.

1 x 4 Litre Light	ORDER CODE: BCRSL004
1 x 4 Litre Dark	ORDER CODE: BCRSD004
1 x 20 Litre Light	ORDER CODE: BCRSL020
1 x 20 Litre Dark	ORDER CODE: BCRSD020

## NOURISH & PROTECT WOOD PRESERVER



A high quality low odour solvent based, deep penetrating preserver which is used for the protection against wood destroying fungi (wet rot) , wood discolouring fungi and wood boring insects. Provides a semi-transparent matt / satin finish allowing the natural wood texture to be visible. Also no subsequent topcoat product is required unless for aesthetic purposes. For outdoor use and also for use on windows/frames, external doors/frames (internal & external sections). Other pack sizes and colours available. Contact the sales office for details.

Colour: Dark Brown



2 x 5 Litre	ORDER CODE: BWOLB005
1 x 25 Litre	ORDER CODE: BWODB025

## NOURISH & PROTECT WOOD PROTECTIVE TREATMENT



An ideal wood treatment for outdoor timber structures such as Sheds, Fences, Trellis, Pergola and timber Gazebo's. A low build film product that absorbs into the wood with successive coats building onto the surface to give excellent water repellency and beading. Oil / Solvent based for deeper penetration of substrate. Contains water repellent resins and film biocide preserver to prevent surface growth of mould / algae and together this helps reduce decay, swelling, twisting of wood. Pigments have good UV fade resistance. Friendly to beneficial insects when dry. Other pack sizes and colours available.

Colour: Dark Brown



2 x 5 Litre	ORDER CODE: BPTDB005
1 x 25 Litre	ORDER CODE: BPTDB025

## PREMIER CLEAR PRIMER UNIVERSAL PRESERVER



Clear Universal Wood Preservative (CUWP) is a solvent-borne ready to use product. It contains active ingredients effective against wood destroying and wood discolouring fungi and against wood-boring insects. CUWP penetrates wood quickly and thereby gets deep into inner layers. It is moisture regulating and provides an adhesive surface suitable for glues, fillers, and solvent or water-based finishing treatments such as paints, varnishes and stains.

2 x 5 Litre	ORDER CODE: BUPCL005
-------------	----------------------

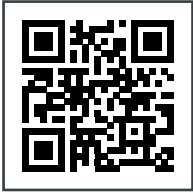

# WOOD PRESERVATION & TREATMENTS

## KNOCKOUT® PATHWAY & PATIO CLEANER



Heavy duty acid-based cleaner, removes grime, dirt, leaf stains and is suitable for cleaning brickwork. Not suitable for use on calcareous or polished stone or tarmac. Always wear eye protection. Age-restricted.



Each

ORDER CODE: BPCA004

## KNOCKOUT® DRIVEWAY, DECKING & PATIO CLEANER



For cleaning patios, decking areas, concrete driveways / pathways and block paving. Kills unsightly mould, fungi and algae from decking, patios and other hard surfaces whilst cleaning general dirt and grime from the surface. Ready to use.

4 x 4 Litre

ORDER CODE: BDECL004

## KNOCKOUT® MOULD & MILDEW CLEANER



A ready to use surface fungicidal wash containing biocides for the control of organic growths and spores, with a cleaning action to remove light dirt. Can be used externally and internally to eliminate mould, mildew, algae and fungi from masonry, timber, plastic and similar substrates. Leaves the surface clean for further remedial treatment.

Each

ORDER CODE: BKOMM004



### CUSTOMER PRICING

All product pricing is available on our website. Login to your online account to access by scanning the QR Code or go to: [www.barrettineEnv.co.uk](http://www.barrettineEnv.co.uk)



### DON'T HAVE AN ACCOUNT WITH US YET?

Register for free by scanning the QR Code or go to the 'Register' tab on our website homepage.



### BULK PRICING

Contact us for special larger volume pricing. Our sales team will get back to you promptly to review your request.





# BIRD control

PRODUCTS 

PEST CONTROL CATALOGUE 2024/2025

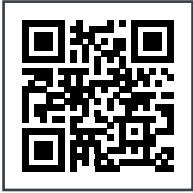

# BIRD REPELLENTS & GUANO CLEANING

## ORNAWAY® BIRD REPELLENT

Ornaway® Bird Gel is a novel, highly effective yet discrete bird deterrent for use on buildings and other structures.

The convenience of Ornaway in pre-filled dishes allows a significant time-saving aspect to the bird installation. The formulation utilises high electromagnetic reflectance spectrums that birds avoid. To be used within an integrated approach to manage birds that could include housekeeping/ cleaning, trapping, spikes and netting. Once properly installed, the product remains effective for at least two years, even in harsh climates.

The gel is intended to be applied in the UV stabilised, low-profile dishes that are supplied with the product. Once installed, the dishes are usually invisible from ground level, so do not detract from buildings' visual appearance.

Ornaway® Bird Gel is also offered in pre-filled dishes as pictured below. The 300 g Caulking Tube includes 15 dishes for filling.



ORDER CODE	DESCRIPTION	PACK SIZE
BBIORGE	Caulking Tube	1 x 300 g
BORNDISH	Pre-filled Dishes	1 x 15

## ORNAWAY® DISH MAGNETS

Ornaway® bird dish magnets offer the user ultimate versatility in the installation of Ornaway® bird gel. The heavy-duty magnets allow the dishes to be securely attached to metallic structures and will remain in place, even in windy conditions.

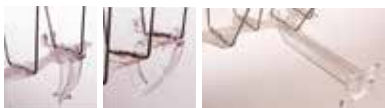

ORDER CODE	DESCRIPTION	PACK SIZE
BBIORMA	Ornaway Dish Magnets	1 x 15
BAVI162	Clips for Gutters	1 x 10
BAVI163	Clips for Lipped Gutters	1 x 10
BAVI171	Clips for Windows	1 x 10

## GUANAWAY®



Disinfectant concentrate (1:24). Contains Didecyltrimethylammonium Chloride for use while cleaning and removing bird waste. Alkaline formula allows acidic residues to be effectively neutralised, preventing corrosion of the building fabric. Broad spectrum elimination of bacteria, viruses and fungi (including *E. coli*, *Covid-19* and *Aspergillus*). Coarse spray allows control of dust. Suitable for use in sprayers and trigger bottles.

1 x 5 Litre	ORDER CODE: BDISB005
-------------	----------------------





Developed by UK scientists.  
Manufactured in the UK.

# When Birds are the problem.

We have the effective & discrete solution.



## Ornaway® Bird Gel | Visual Bird Repellent

### BIRD DETERRENT

Ornaway® Bird Gel is a novel, highly effective yet discrete bird deterrent for use on buildings and other structures.

The convenience of Ornaway in pre-filled dishes allows a significant time-saving aspect to the bird installation. The formulation a high electromagnetic reflectance spectrum that birds avoid.

Ornaway® Bird Gel is offered in pre-filled dishes and a 300 g Caulking Tube that includes 15 dishes for filling.



### INSTALLATION



MAGNETIC DISH

GUTTER CLIP

WINDOW CLIP

SOLAR PANEL

Ornaway® magnets for ultimate versatility, that secure to metallic structures (even in windy conditions) are available along with securing clips for windows, gutters and solar panels.

### SURFACE PREPARATION



Guanaway surface cleaner is a powerful, alkaline cleaner/degreaser that neutralises the acidic by-product associated with bird droppings. Available in a 5 litre concentrate.

**Barrettine**  
Environmental Health

Unit 4 Caxton Business Park, Crown Way,  
Warmley, Bristol BS30 8XJ.  
T: +44 (0) 117 967 2222  
E: beh@barrettine.co.uk  
www.barrettineEnv.co.uk

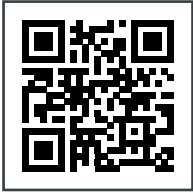

LOGIN TO OUR  
WEBSITE FOR PRICES  
OR REGISTER NOW

# BIRD SPIKES

## P14



**Bird activity:** Pigeons (Daytime perching)  
**Infestation:** Up to medium pressure areas.  
**Where to use:** Pipework and narrow ledges.  
**Protects area:** Up to 115 mm.

**Base width:** 20 mm  
**Distance between wires:** 50 mm  
**Height:** 115 mm  
**Distance between outer spike tips:** 50 mm

ORDER CODE	DESCRIPTION	PACK SIZE
BAVI110	P14	5 m Stack
BAVI110.1	P14-Carton	50 m

## P20



**Bird activity:** Pigeons (Daytime perching & night time roosting)  
**Infestation:** Up to heavy pressure areas.  
**Where to use:** Most building ledges.  
**Protects area:** Up to 205 mm.

**Base width:** 45 mm  
**Distance between wires:** 33 mm  
**Height:** 129 mm  
**Distance between outer spike tips:** 140 mm

ORDER CODE	DESCRIPTION	PACK SIZE
BAVI120	P20	5 m Stack
BAVI120.1	P20-Carton	50 m
BAVI126.1	P20-Carton (Marine Grade)	50 m

## P32



**Bird activity:** Pigeons & Starlings (Perching, roosting & some nesting)\*  
**Infestation:** Up to heavy pressure areas.  
**Where to use:** Most building ledges.  
**Protects area:** Up to 265 mm.

**Base width:** 45 mm  
**Distance between wires:** 21 mm  
**Height:** 139 mm  
**Distance between outer spike tips:** 200 mm

\*For starlings place at least three strips together with wires overlapping

ORDER CODE	DESCRIPTION	PACK SIZE
BAVI130	P32	5 m Stack
BAVI130.1	P32-Carton	50 m
BAVI136.1	P32-Carton (Marine Grade)	50 m

## G20



**Bird activity:** Gulls (Perching, roosting & some nesting)\*  
**Infestation:** Up to heavy pressure areas.  
**Where to use:** Most building ledges.  
**Protects area:** Up to 375 mm.

**Base width:** 45 mm  
**Distance between wires:** 33 mm  
**Height:** 166 mm  
**Distance between outer spike tips:** 175 mm

\*Due to gulls strength installations need to prevent birds from landing adjacent to areas being protected.

ORDER CODE	DESCRIPTION	PACK SIZE
BAVI140	G20	5 m Stack
BAVI140.1	G20-Carton	50 m

# BIRD SPIKE CLIPS & SEALANT

## CLIPS FOR GUTTERS

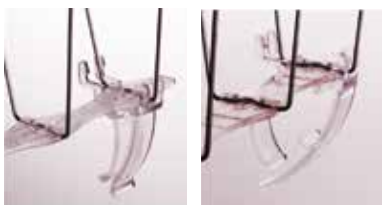

Clips for Gutters fit securely onto the base of P14, P20, P32 and G20 Bird Spikes. The clips for Gutters allows the spike strips to be clipped onto the side of a wide variety of gutters, allowing free flow of water underneath. Two clips are required per strip. Clips for Lipped Gutters fit securely onto the base of P14, P20, P32 and G20 Bird Spikes. They allow the spike strips to be clipped onto the side of a variety of lipped gutters, including many international style gutters, allowing free flow of water underneath. Two clips are required per strip.

ORDER CODE	DESCRIPTION	PACK SIZE
BAVI162	Clips for Gutters	10
BAVI163	Clips for Lipped Gutters	10

## CLIPS FOR WINDOWS & SOLAR PANELS



Clips for Windows fit securely onto the base of P20, P32 and G20 Bird Spikes. They allow the spike strips to be easily secured onto window frames using White adhesive or screws. These clips are extremely useful as they allow the spikes to protect the window sill without hindering the operation of the window. Two clips are required per strip.

Clips for Solar Panels fit both solar panels and roof ridges it is easily glued or screwed in to place. These clip securely into place and are compatible with P14 and P20, P32 & G20. Made from a UV stable polycarbonate material which is compatible with 90°, 105° and 125° roof tiles and compatible with both 45° and 37.5° solar panels.



ORDER CODE	DESCRIPTION	PACK SIZE
BAVI171	Clips for Windows	10
BAVI191	Clips for Solar Panels	10

## AVISIL



For use with a caulking gun, this is a professional product that cannot be found in DIY shops. Avisil is vastly superior to ordinary clear DIY silicone due to its ease of application, it stays permanently elastic after curing, Avisil has a high temperature resistance and UV resistance. A clear, high quality, neutral-curing silicone adhesive, Avisil is recommended for use where the surface is dry. It offers excellent adhesion on most building materials. One tube (310 ml) of Avisil can install up to 15 m of bird spikes.

ORDER CODE	DESCRIPTION	PACK SIZE
BADH001	Avisil	310 ml



### CUSTOMER PRICING

All product pricing is available on our website. Login to your online account to access by scanning the QR Code or go to: [www.barrettineEnv.co.uk](http://www.barrettineEnv.co.uk)



### DON'T HAVE AN ACCOUNT WITH US YET?

Register for free by scanning the QR Code or go to the 'Register' tab on our website homepage.



### BULK PRICING

Contact us for special larger volume pricing. Our sales team will get back to you promptly to review your request.



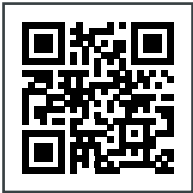

LOGIN TO OUR  
WEBSITE FOR PRICES  
OR REGISTER NOW

# BIRD TRAPS

## PIGEON TRAPS

All pigeon traps are flat packed and easy to assemble. When assembled, the dimensions are 1 m x 60 cm x 30 cm. Two sets of 'bob-wire' entrances are supplied as standard in all the traps. If required, these can be replaced with ground funnel entrances, available as an optional extra.



ORDER CODE	DESCRIPTION	PACK SIZE
BTRA029	Feral Pigeon Trap with floor	Each
BTRA050	'Foldaway' Feral Pigeon Trap no base	Each

## FERAL PIGEON TRAP

A live catch trap constructed using square galvanised mesh. Entrances with easy swing bob wires and top access for removing captured birds. Comes flat packed and complete with vinyl base for easier pre-baiting or without vinyl base if preferred.



WITH VINYL BASE

Each

ORDER CODE: BTRA029

WITHOUT VINYL BASE

Each

ORDER CODE: BTRA050





**Barrettine**  
Environmental Health



**NEW &  
IMPROVED**

# Guanaway

Concentrate (5 Litre)

**Heavy Duty**  
Alkaline Cleaner Disinfectant

A concentrate and ready to use professional spray for use in the control of microorganisms associated with the cleaning up of bird waste. Guanaway passes BS6471 against *E. coli* and contains a powerful degreaser to neutralise the acid deposits associated with bird droppings.



Barrettine   
**Guanaway**  
Concentrate  
Heavy Duty  
Cleaner and Broad-Spectrum Disinfectant

- Most effective for use in home removal and cleaning
- Effectively controls bacteria, viruses and fungi
- Broad spectrum germicidal action against organisms such as *E. coli* and *S. aureus* (BS6471)

**RATIO 1:24**





# APPLICATION equipment

PRODUCTS

PEST CONTROL CATALOGUE 2024/2025

If you are unsure which insecticides can be applied through the various applicators, then please see our A-Z charts within the Technical Section to the rear of the catalogue.

# FOGGERS

# APPLICATION equipment PRODUCTS

APPLICATION EQUIPMENT - FOGGERS

## FOGMASTER TRI-JET FOGGING MACHINE



The Commander Tri-Jet Fogger is suitable for chemical fogging (using pesticides, sanitisers etc.) and can also be used for humidifying.

With adjustable particle size and discharge rate, the Tri-Jet can mist up to 9 metres in any direction indoors or outdoors. Also ideal for deodorising smoke contaminated buildings, and the fine fog can be used to penetrate porous materials. Pest control, odour control, and disinfection or sanitising are just a few of the many uses for this product.

Aluminium housing, fuel and oil resistant vinyl tubing, and brass control valves and fittings round out this sturdy apparatus.

The Tri-Jet is CE approved and can be used with water and oil-based liquids.

Each

ORDER CODE: BTRIJETF

## FOGMASTER JUNIOR



Fogmaster Jr. is a compact, general usage ULV fogger with a wide variety of applications, from removing unpleasant odours and moulds from indoor places to applying water & oil-based insecticides. As the manufacturer states, this fogger is for those jobs for which an industrial fogger is too large and a hand sprayer is too small. This fogger comes with a UK plug.

Each

ORDER CODE: BFOGJUNI

## ULV APPLICATOR



A simple robust Ultra low volume applicator for use to apply Grain-Tect ULV and K-Obiol ULV - 6 formulations to grain. Kit includes pump, nozzle, air and liquid transfer tubing pressure regulator.

Each

ORDER CODE: BULVAPLI

Save time, place your order online.



PAY ONLINE

BarretlineEnv.co.uk



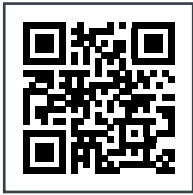

LOGIN TO OUR  
WEBSITE FOR PRICES  
OR REGISTER NOW

# SPRAYERS

## GLORIA 510T



The Gloria 10 litre stainless steel sprayer. Has the same specification as the 505T but a larger 10 litre capacity.

10 Litre

ORDER CODE: BSPGL142

## GLORIA TYP 89



Gloria special pressure sprayer Typ 89 has got a capacity of one litre and a maximum operating pressure of 3 bar. Its highlight is the adjustable nozzle with swivelling head that enables spraying into corners that are difficult to access.

1 Litre

ORDER CODE: BSPGLPL1

## GLORIA 405T



Gloria 405 T Profiline has got a pressure tank made of steel with a high-quality internal plastic coating and a capacity of 5 litres that stands out due to its high durability. Contact between aggressive media and steel tank is avoided thanks to the coating, and cleaning is considerably easier. The high-performance sprayer works with an operating pressure of 6 bar and impresses with its equipment and a wide range of use.

5 Litre

ORDER CODE: BSPGL176



### CUSTOMER PRICING

All product pricing is available on our website. Login to your online account to access by scanning the QR Code or go to: [www.barrettineEnv.co.uk](http://www.barrettineEnv.co.uk)



### DON'T HAVE AN ACCOUNT WITH US YET?

Register for free by scanning the QR Code or go to the 'Register' tab on our website homepage.



### BULK PRICING

Contact us for special larger volume pricing. Our sales team will get back to you promptly to review your request.





## GLORIA SPARE PARTS

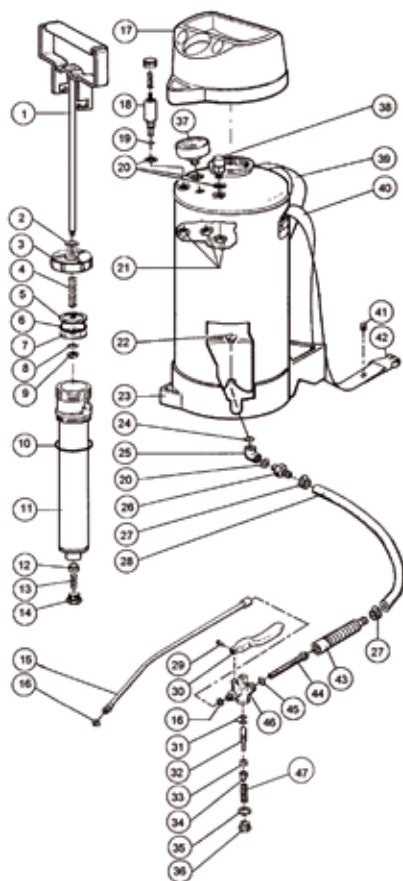

KEY	DESCRIPTION	PART No.	KEY	DESCRIPTION	PART No.
1	Piston rod with handle - bare	709150	29	Rivet for trigger lever	633070
2	Buffer washer for pump	611170	30	Lever for trigger valve	600680
3	Pump cap / piston guide	605843	31	O ring for trigger spindle	606571
4	Buffer spring for pump	610471	32	Valve spindle without O rings	607472
5	Piston plate - dished	624230	32	Valve spindle with O rings	711430
6	Piston O ring	625971	33	Rubber valve disc	602070
7	Piston plate - flat	624330	34	Housing for valve disc	602570
8	Locking washer	200110	35	Washer for base plug	602270
9	Hexagon nut for piston rod	634170	36	Base plug for trigger valve	602370
10	Pump sealing O ring	627070	37	Pressure gauge, nut & washer	706410
11	Pump barrel	711210	38	Relief valve with washer	706550
12	Footvalve poppet	701980	39	Strap c/w studs for 141T	620140
13	Spring for footvalve	615972	39	Strap for 176T - has no fittings	609834
14	Retaining plug for footvalve	605000	39	Strap142T/172RT not for hook	620130
15	Lance tube with washer	701310	40	Strap142T/172RT - for hook	604530
16	Washer for lance and trigger	617070	41	Stud for carrying strap	603060
17	Black filler funnel 10 litre	604240	42	Hook for carrying strap	604410
17	Blue filler funnel 10 litre	604250	43	Filter barrel for trigger	511760
17	Blue filler funnel 5 litre	604270	44	Strainer for trigger valve	613320
17	Black filler funnel 5 litre	604280	45	O ring for filter barrel	512670
18	Decompression valve c/washer	709080	46	Body for trigger valve	511820
19	O Ring for decomp'n valve	213440	47	Spring for trigger valve	612071
20	Washer for gauge	618170	48	Black plastic base 141T	604420
21	Hexagon nut for gauge	604500	48	Black plastic base 142T	604430
22	Screw for container outlet	538683	49	Brass nut for nozzle holder	00-400
23	Blue plastic base for 176T	538726	50	Nozzle tip - please specify	Various
23	Blue plastic base for 172RT	538725	51	Nozzle sealing washer	00-349
24	O ring seal for outlet elbow	130090	52	Nozzle strainer 100 mesh	02-028
25	Outlet adaptor elbow	538682	53	Strainer 50 mesh blue P/P	02-416/50
26	Tank outlet adaptor w/o washer	602800	54	Brass body for nozzle holder	00-402
26	Tank outlet adaptor c/w washer	712650	55	Cap for adjustable nozzle	601900
27	Worm drive hose clip	602900	56	O ring for adjustable nozzle	601910
28	Hose 1.3 metres c/w clips	706950	57	Body of adjustable nozzle	601920

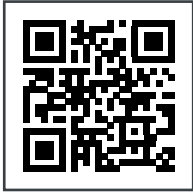

# SPRAYERS SPARES

## SPARES FOR GLORIA 505, 405, 510 & 410



HOSE ASSEMBLY	
Each	ORDER CODE: BSPGLO5H
GLORIA SEAL KIT	
Pack	ORDER CODE: BSPGSEAL
CRACK/CREVICE NOZZLE	
Each	ORDER CODE: BSPGCCRN

## SEAL KITS, REPAIR KITS & ASSEMBLIES

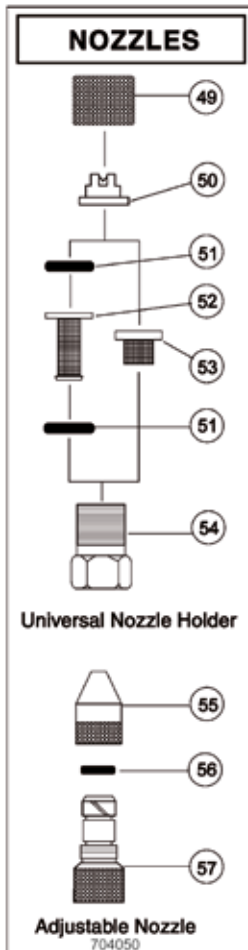

DESCRIPTION	PART No.	KEY NUMBERS INCLUDED IN ITEM
Complete Seal Kit	707270	6, 10, 12, 16, 19, 20, 31, 33, 35, 45, 51, 56.

PUMP GROUP		
DESCRIPTION	PART No.	KEY NUMBERS INCLUDED IN ITEM
Piston rod assembly complete	710260	1, 2, 3, 4, 5, 6, 7, 8, 9.
Piston end components	706490	5, 6, 7, 8, 9.
Pump barrel with footvalve	712410	10, 11, 12, 13, 14.
Footvalve components	725790	12, 13, 14.
Pump assembly complete	710240	1, 2, 3, 4, 5, 6, 7, 8, 9, 10, 11, 12, 13, 14.

TRIGGER VALVE & HOSE GROUP		
DESCRIPTION	PART No.	KEY NUMBERS INCLUDED IN ITEM
Seal kit for trigger valve	706560	16, 31, 33, 35, 45.
Pack of 10 x 617070 washers	706870	16.
Trigger Valve complete	707340	16, 27, 29, 30, 31, 32, 33, 34, 35, 36, 43, 44, 45, 46, 47.
Trigger Valve repair kit	711600	31, 32, 33, 34, 47.
Hose complete with ends	00-605	20, 26, 27, 28, 43.

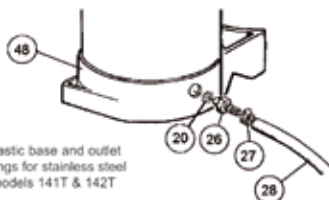

Plastic base and outlet fittings for stainless steel models 141T & 142T

SPRAY LANCE		
DESCRIPTION	PART No.	KEY NUMBERS INCLUDED IN ITEM
Lance tube with washer	701310	15, 16.

# DUSTERS

# APPLICATION equipment PRODUCTS

## DR5 PROFESSIONAL POWDER DUSTER



A 5 litre tank that holds approximately 3-4 Kg of insecticide powder/dust. It works at a maximum operating pressure of three bar. Other features include pressure relief valve and air valve.

Each

ORDER CODE: BSPBIDU5

## DR5 SUPPORT HANDLE

For use with DR5 lances to provide additional stability.



Handle - Each

ORDER CODE: BDR5SUHA

## DR5 ALUMINIUM RIGID LANCES



Can be used with dusts and liquids, can also be used with Gloria sprayers.

1 x 1.5 m

ORDER CODE: BDR5EL15

## DR5 1-2 METER TELESCOPIC LANCE



Aluminium lance is sent out complete with a 1/4 inch brass nut to allow connection to existing applicator (included in cost).

Each

ORDER CODE: BSPDU5EX

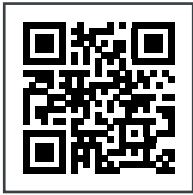

  
**LOGIN TO OUR WEBSITE FOR PRICES**  
**OR REGISTER NOW**

# DUSTERS & SPARES

## DR5 SPARE PARTS

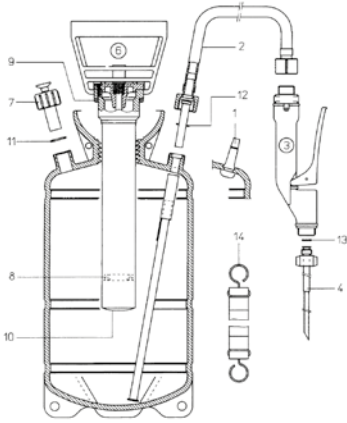

Replacement parts can be purchased from the list below. Please check you have the item against the diagram below.

PRODUCT	ORDER CODE
DR5 Professional Powder Duster	BSPBIDU5
DR 5 Injector needle, curved	BSPD5INJ
1. Valve	BSPD5VAL
2. Hose assembly	BSPD5HOS
3. Pistol valve assembly	BSPD5TRI
6. Pump assembly	BSPD5PUM
14a. Gasket set	BSPD5GAS

## THE DUSTICK

Ideal tool for target dusting from over 20 ft away. The durable, heavy-duty brass pump provides superior pressure. The four lightweight aluminium extensions can be assembled and dismantled in seconds. Heavy-duty carrying bag is also included. Full range of Duststick spares in stock.



Each	ORDER CODE: BSPDSTIC
------	----------------------

## DUSTSTICK SPARE PARTS



PRODUCT	ORDER CODE
1: Zipper Bag	BSPDU001
2: Aluminium Poles	BSPDSPOB
3: Aluminium Poles with button	BSPDSPOB
4: Dust Canister	BSPDU003
5: Pump Connection Adaptor	BSPDU005
6: Dust Canister Adaptor	BSPDUADA
7: Rubber Stopper	BSPDU008
8: Pump Repair Kit	BSPDU009
9: Pump O'Ring	BSPDU010
10: Pump Knob	BSPDU012
11: Nozzle Cap	BSPDU013
12: Aluminium Pole O'Ring	BSPDU014
13: Rubber Grip	BSPDU015
14: Nozzle Set (While stocks last)	BSPDUNOZ



# BAIT GUN APPLICATORS

# APPLICATION equipment

PRODUCTS

## B & G MULTI DOSE GUN



The Multi-Dose Gun allows you to precisely place gels. One pull gives you the same dose each time. Instant selection from six different gel and paste sizes. Placement sizes specifically designed for roach & ant control. No need to calibrate- just select the size and pull.

Each

ORDER CODE: BBGMULDO

## SPX PLASTIC BAIT GUN



A high quality, light weight, cost effective plastic bait gun. Gun provides pressure relief at end of stroke to control run-on.

Each

ORDER CODE: BBGSPXPL

## SKELETON CAULKING GUN



This Skeleton caulkung gun is suitable for 310 ml cartridges with a length of up to 220 mm.

Each

ORDER CODE: BBGHDCAS

## BESPOKE COMPANY ONLINE ORDERING FACILITY

It's time to simplify handling the needs of your employees.

Whether it's selecting stock from a pre-approved product list or reporting on stock levels held by your technicians, we've got you covered. Ordering supplies from us is simple for you and your staff. All order requests can be tailored for management approval before dispatch. We can create a custom ordering process designed just for your business. Once approved, your order is sent to our sales team for immediate dispatch.

>> Save time >> Save money >> Streamline your process!

Contact our team and enquire today.



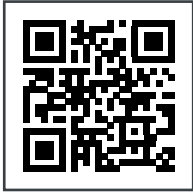

  
 LOGIN TO OUR WEBSITE FOR PRICES  
 OR REGISTER NOW

# TORCHES, DECANTING & MIXING

## ULTRAVIOLET TRACKER TORCH

Ideal for use with tracking dusts, non toxic fluorescent baits as well as fluorescent rodenticides.



Each

ORDER CODE: BUVTLAMP

## MULTI-FUNCTION HIGH POWER LED & ULTRAVIOLET TORCH



A multipurpose LED torch with a spotlight beam reaches a distance of 200 metres. This 3-in-1 torch has an adjustable LED high-power spotlight, UV mode, and lantern function in one compact package, making it the perfect tool for pest inspections. The base has a strong magnet that allows hands-free operation by attaching it to metal surfaces.

High, Low, Strobe, UV light, Side White light, Red light, and a White and Red Strobe - 1200 Lumen (max) power - this rechargeable torch has seven different light settings. USB Fast Charging - includes a rechargeable 18650 battery and a charging cable.

Each

ORDER CODE: BPROTORC

## PLASTIC MEASURING SCOOP

**PLASTIC MEASURING SCOOP:**  
This white 100 ml plastic scoop is ideal for decanting rodenticide.



100 ml Scoop

ORDER CODE: BSCOO100

Whilst you are here...  
Follow us on Facebook!

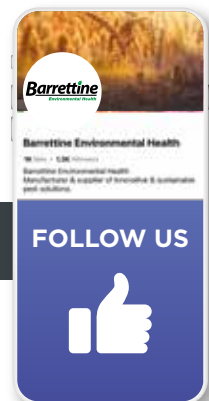

Keep up to date with our latest products and deals!

 GROWING COMMUNITY

 EXPLORE OUR WEEKLY POSTS

 LATEST PRODUCTS & PROMOTIONS



# PPE & safety

PRODUCTS

PEST CONTROL CATALOGUE 2024/2025

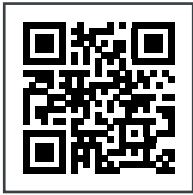

  
**LOGIN TO OUR WEBSITE FOR PRICES**  
 OR REGISTER NOW

# PROTECTIVE CLOTHING

## TYVEK PROTEC CLASSIC



Chemical and dust resistant, hooded with sewn seams, elasticated waist, arms & legs. Type 5 & 6 131N non woven high density polyethylene.

Large

ORDER CODE: BPCTYCLL

## ULTRA NITRILE 487 GLOVES



A 32 cm Gauntlet, lined in sizes of 8.5, 9.5 and 10 .5. Liquid proof glove, mechanical risks 3101. EN388 & EN374. Standard outer 10 pairs.

Pair - 8.5

ORDER CODE: BG4878.5

Pair - 9.5

ORDER CODE: BG4879.5

## DISPOSABLE NITRILE GLOVES



A 100 % nitrile glove giving good level protection against minor nicks, cuts and abrasions. Slightly longer for improved protection. Standard outer 50 pairs. Priced per box.

Large

ORDER CODE: BGTNTRLG

X Large

ORDER CODE: BGTNTEXL



### CUSTOMER PRICING

All product pricing is available on our website. Login to your online account to access by scanning the QR Code or go to: [www.barrettineEnv.co.uk](http://www.barrettineEnv.co.uk)



### DON'T HAVE AN ACCOUNT WITH US YET?

Register for free by scanning the QR Code or go to the 'Register' tab on our website homepage.



### BULK PRICING

Contact us for special larger volume pricing. Our sales team will get back to you promptly to review your request.





# CARTRIDGE MASKS & FILTERS

## RESPIRATOR FULL FACE 3M™ 6800 MASK



Each

ORDER CODE: B3M6800

The 6000 series Full Face Respirators are used with a twin lightweight filters which are fitted by a simple bayonet attachment system, providing an economical and flexible choice. The Respirators can also be used with the 3M S-200 supplied-Air System for increased convenience and flexibility. This is a medium fit, large is also available.

## 3M™ 7500 HALF MASK



Each

ORDER CODE: BMA3M75H

The 3M™ 7500 half mask is a reusable soft silicone mask that is comfortable for the user to wear. The 3M™ Cool Flow™ valve allows for easier breathing and reduced heat and moisture build-up when in use. The twin filters provide even weight distribution for added comfort and minimise obstruction of vision making it easier to use.

## 3M™ FILTERS & RETAINER COVER



A2 Filter

ORDER CODE: BMA3FA2F

P3 Filter

ORDER CODE: BMA3FIP3

Retainer Cover

ORDER CODE: BMA3FRET

**Note:** If you require P3 filters you must incorporate A2 filters plus the retaining cover.

Save time, place your order online.



**PAY ONLINE**

BarretlineEnv.co.uk



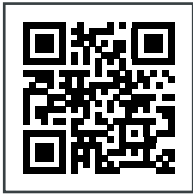

# MOULDED RESPIRATORS

## 3M™ 4255 DISPOSABLE RESPIRATOR MASKS

A2P2 Organic vapour & particulate dust protection. EN405



Each

ORDER CODE: BRESP3M4

## 3M™ AURA RANGE - VALVED MASKS



Introducing the 3M Aura Series disposable respirators. Features particulate filter material with advanced low breathing resistance filter technology. Gives effective filter performance whilst lowering resistance to breathing. Improved breathing ease and comfort. Effectively removes heat build up, providing a cooler and more comfortable wear. Removes exhaled air and minimises the risk of fogging eyewear.

P3 Valved mask suitable for dusts, mists and fumes.

Pack of 10.

P3 Filter

ORDER CODE: B3AURAP3

## TECHNICIANS FIELD GUIDE

A complete and essential guide for the professional.

- FLYING INSECTS
- CRAWLING INSECTS
- RODENT PESTS
- BIRD PESTS
- SPI, AGRICULTURE & AMENITY PESTS

The Barretline's pocket-size A6 Pest Technicians guide contains detailed information to assist in the daily routine of a Professional Pest Control Operator: A 'how to' guide covering topics of insect and rodent information and identification, equipment calibration, non-chemical insect control measures, pesticide application and product safety, dealing with waste: Triple rinsing as well as detailed information on LD<sub>50</sub>.

ORDER CODE: BPIDBOOK



# HYGIENE & DISINFECTANTS

**NEW**

## KNOCKOUT® MAX STRENGTH DISINFECTANT



An all-purpose, ready-to-use formulation suitable for use on a wide variety of surfaces. Next generation formula proven to kill bacteria, viruses and fungi including Covid-19. Ideal for use in and around domestic premises, kennels and other sensitive areas. Kills 99.9% of bacteria and viruses, including: *Bactericidal, Yeasticidal, Bactericidal + Yeasticidal, Fungicidal, Full Virucidal + SARS-CoV 2, Salmonella, Listeria and Campylobactor.*

1 x 1 Litre

ORDER CODE: BKOODI01

## KNOCKOUT® MOULD & MILDEW CLEANER



A ready to use surface fungicidal wash containing biocides for the control of organic growths and spores, with a cleaning action to remove light dirt. Can be used externally and internally to eliminate mould, mildew, algae and fungi from masonry, timber, plastic and similar substrates. Leaves the surface clean for further remedial treatment.

Each

ORDER CODE: BKOMM004

**KILLS  
LEPTOSPIROSIS**

## GUANAWAY CONCENTRATE



Disinfectant and cleaner for use with the cleaning up bird waste, kills fungi associated with bird droppings. Unlike other products, Guanaway is a powerful alkaline cleaner degreaser that neutralises the acidic by-product associated with bird droppings. This reduces the damage to the stonework and increases safety by removing the slippery, greasy waste. Ideal for disinfecting traffic lights, as it won't discolour plastic.

1 x 5 Litre  
(Concentrate)

ORDER CODE: BDISB005



### CUSTOMER PRICING

All product pricing is available on our website. Login to your online account to access by scanning the QR Code or go to: [www.barrettineEnv.co.uk](http://www.barrettineEnv.co.uk)



### DON'T HAVE AN ACCOUNT WITH US YET?

Register for free by scanning the QR Code or go to the 'Register' tab on our website homepage.



### BULK PRICING

Contact us for special larger volume pricing. Our sales team will get back to you promptly to review your request.



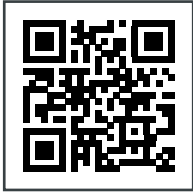

  
**LOGIN TO OUR WEBSITE FOR PRICES**  
 OR REGISTER NOW

# HYGIENE & DISINFECTANTS

## KNOCKOUT® BIOLOGICAL DRAIN TREATMENT



An eco-friendly, enzyme-based biological formulation to clear slow flowing waste pipes in the bathroom and kitchen. Use regularly as a maintenance product. Safe to use on septic tanks.

6 x 1 Litre

ORDER CODE: BKOBD001

## KNOCKOUT® CAUSTIC SODA



Granules for dissolving in cold water to clear block drains and clean surfaces. Can be used to strip paint. Will need neutralising with white vinegar. Age restricted.



500 g

ORDER CODE: BCSA6.50

1 Kg

ORDER CODE: BCSA6001

4 Kg

ORDER CODE: BCSAK004

## KNOCKOUT® DRAINS TOILETS & URINALS



Knockout drains, toilets & urinals special formulation is ready to use, and will break down the fats, grease and hair that commonly cause blockages or slow running wastes, leaving waste pipes clean and sanitised. Drains, Toilet & Urinals (DTU) is a caustic/sodium hydroxide-based product designed to clear blockages caused by organic substances. Age restricted.



4 x 1 Litre

ORDER CODE: BODT001

**Whilst you are here...**  
**Follow us on Facebook!**

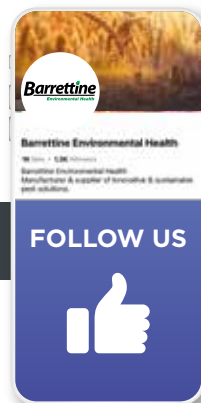

Keep up to date with our latest products and deals!

 GROWING COMMUNITY

 EXPLORE OUR WEEKLY POSTS

 LATEST PRODUCTS & PROMOTIONS



## A GUIDE TO THE BARRETTINE RANGE OF PERSONAL PROTECTIVE EQUIPMENT COSHH AND PPE REGULATIONS

The COSHH Regulations 2002, as amended in 2003 and 2004 are a key part of health and safety at work. The regulations place a legal requirement on all employers and operators including self-employed people to undertake an assessment of the risks created by exposure to any substances hazardous to health. The risk assessment shall include consideration of the hazardous properties of the substance, manufacturers information contained in any material safety data sheet, the level and type of duration of exposure, working circumstances and other factors relating to exposure limits, control measures etc.

The COSHH amendment Regulation 2004 which came into force on 1st April 2005. It introduced a new framework of adequate control of exposure by specifying principles of good practice (Schedule 2A) and by replacing occupational exposure standards (OES's) and Maximum Exposure levels (MEL's) with workplace exposure limits (WEL's).

The Personal Protective Equipment Regulations 1992 require that where PPE is issued it must be suitable for the task for which it is required, and it must take into account the demands it places on the worker. It must be maintained in good condition and stored when not in use in a clean cabinet or container.

### What does this mean to you?

The provisions make the duty holders focus on applying principles of good practice to controlling exposure rather than compliance with any OEL. (Schedule 2A)

This has the effect of bringing into the definition of adequate control all substances within the scope of the COSHH regulations, irrespective of whether they have an OEL, and all routes of exposure i.e. inhalation, absorption and ingestion and injection. It is now accepted that it is not possible to give a "Safe limit" as before because in practice a guarantee for health protection for all individuals, even if exposure is below a specified limit, is not scientifically secure.

The revised system of WEL's will be set by the advisory committee on toxic substances (ACTS). These are listed in a publication EH40-2005. There is a specific WEL values in Table 1 for all substances. The WEL value is a limit that must not be exceeded and there is a duty, similar to the previous regulations, to ensure adequate control and to reduce exposure as far as possible.

The amendments to COSHH should make it easier for enforcers and duty holders to determine whether exposures to substances are adequately controlled and proportionate to the risk.

As part of the Barrettine professional services, we have available qualified COSHH Consultants who are able, on a fee basis, to undertake COSHH Assessments and preparation of COSHH documentation for our customers, as well as being able to define the personal protective equipment required in the specific situations encountered by our customers. In addition we are happy for our staff to offer advice, at no charge, on the level of protection required in applying and using any of the PPE products which we offer as part of our Technical Sales Service to our customers.

### Schedule 2A

Principles of good practice for the control of exposure to substances hazardous to health.

The eight principles of good practice for the control of exposure to substances hazardous to health are set out in Schedule 2A of The Control of Substances Hazardous to Health Regulations 2002 (as amended). Approved Code of Practice and guidance .

### The principles are reproduced below:

- (A) Design and operate processes and activities to minimise emission, release and spread of substances hazardous to health;
- (B) Take into account all relevant routes of exposure - inhalation, skin absorption and ingestion - when developing control measures;
- (C) Control exposure by measures that are proportionate to health risk;
- (D) Choose the most effective and reliable control options which minimise the escape and spread of substances hazardous to health;
- (E) Where adequate control of exposure cannot be achieved by other means, provide, in combination with other control measures, suitable personal protective equipment;
- (F) Check and review regularly all elements of control measures for their continuing effectiveness;
- (G) Inform and train all employees on the hazards and risks from the substances with which they work and the use of control measures developed to minimise the risk;
- (H) Ensure that the introduction of control measures does not increase the overall risk to health and safety. If employers apply the principles correctly, exposure should be below any relevant WEL. Control by personal protective equipment should only be used when other measures are not reasonably practicable. The list of WEL's applies to concentrations of hazardous substances breathed in by the worker and are used to determine the adequacy of control measures. There are several publications, which give advice and guidance on what is required under the COSHH Regulations.

### Regulation 7 COSHH 2002. Fit Testing of Facepieces

The performance of RPE with a tight-fitting facepiece (filtering facepieces, half and full full-face masks) depend on a good contact between the wearer's skin and the face seal of the mask. A good face seal can only be achieved if the wearer is clean-shaven in the region of the seal and the facepiece is the correct size and shape to fit the wearer's face. Employers should ensure that the selected facepiece (tight and loose fitting types) is of the right size and can correctly fit each wearer. For a tight-fitting facepiece (filtering facepieces usually known as disposable masks, half and full face masks) the initial selection should include fit testing to ensure the wearer has the correct device. Barrettine can advise customers about this requirement.

# WHY CHOOSE BARRETTINE?

## WHY CHOOSE BARRETTINE AS YOUR PREFERRED SUPPLIER?

### QUALITY PRODUCTS

As well as working directly with the key major Biocide Manufacturers, Barrettine manufacture and source a fantastic wide range of products, many of which are award-winning, helping you and your business to stay ahead.

#### Discretion is key. We're not your competitor!

Unlike some other distributors we are careful how and where product prices are displayed.

Our products are only sold to qualified Pest control Companies/ Technicians or recognised distributors with appropriate facilities.

### TECHNICAL SUPPORT, PRODUCT STEWARDSHIP, REGULATORY & LEGISLATIVE UPDATES.

Professional products are only sold onto qualified/competent personnel that can demonstrate they have the required training and qualifications.

### QUALIFIED STAFF

Barrettine at the heart of our industry, constantly update Customers with the ever-changing regulatory & legislative issues we must implement. A number of Barrettine staff represent the company and the industry within a number of independent bodies and organisations such as the NPTA & CRRU.

### TRAINING

Barrettine is a Lantra approved Training provider have put together a number of excellent, independent and recognised training courses to help support your business, your staff & colleagues. Contact the Sales office for further information.

### FREE INSECT ID

From an independent industry-leading entomologist, quick and easy and free to our Customers.

### BARRETTINE GROUP CORPORATE & SOCIAL RESPONSIBILITY

(Full policy document available on request)

We recognise that we must integrate our business values and operations to meet the expectations of our stakeholders. This includes our Customers, Employees, Investors, Suppliers, the Community and the Environment.

The Board of Directors supports this principle and the aim of our full policy is to translate this into guidelines, standards and actions that set a common approach for all employees within our Business.

### PURPOSE & AIMS

The Barrettine Group Mission is:

- To enhance our expertise in our key Business activities; Chemical Formulations, Chemical Products, Chemical Handling, Biocides & Product Development.
- Give priority to Customer service and Flexibility
- Offer value for money, Sustainable Products & Services that meet the demands of our Customers and markets, whilst being acceptable to the Environment.
- Target and achieve the highest quality standards in all we do.
- Honesty & Integrity, Always Trustworthy

These core values continue to help us achieve our overall objective; A strong performing business respected by our Customers & Supply Partners, envied by our Competitors.

### CODE OF BUSINESS ETHICS

We recognise that good CSR embraces all aspects of sustainable development and the way we affect people through our business operations. Therefore, our CSR applies to all of the operations of the Company and its subsidiaries and sets out the minimum standards expected from staff in their internal and external dealings with colleagues, customers, stakeholders and third parties.

Our full range of policies cover: Employees - Equality - Human Rights - Modern Slavery - Environment - Quality Control - Sustainability - Impact on society - Ethics & Ethical Trading.

### ENVIRONMENT

ISO 14001 Standard.

(Full Environmental Policy available on request)

### QUALITY MANAGEMENT SYSTEM

ISO 9001 Standard. (Full policy available on request)

### SUSTAINABILITY - IMPACT ON SOCIETY - ETHICS AND ETHICAL TRADING

(Full policy document available on request).

- Our Sustainable policy will be maintained and it sets out the principles, policies and procedures on which sustainable business activity within Company will be based. The policy acts as a prompt to staff to consider sustainability as a factor in all key decisions;
- We take steps to understand how we can most effectively support the needs of the local and wider community and implement initiatives accordingly; A number of Charities are supported by both the Business as well as individual Employee fundraising events.

### TOTAL SERVICE

- Barrettine strive to complete your order and deliver next day, we will always advise if there are any issues beforehand.
- A full competitive package. We will do our best to match, or beat any price on offer.

### MORE THAN JUST A SUPPLIER.

A true partner to support your business, the right Chemistry!



# A-Z RODENT control

PRODUCTS

The following charts have been produced only as an aid in product selection and to summarise some key points. Before using any of the rodenticides listed, a thorough site inspection and plan should be carried out. In all circumstances you should always read the product label. The information given in the table is to the best of our knowledge and is given in good faith at the time of print. We cannot accept any responsibility for loss or damage arising from any error or omission. You should always refer to the product SDS and label before use. Refer to the CRRU code for the Best Practice Guidelines.



## CONTRAC BLOX UK AUTHORISATION NUMBER GB-2015-0941

ACTIVE % & TYPE	AREA OF USE	EFFECTIVE AGAINST	DOSAGE / QUANTITY GUIDE	PERMANENT BAITING APPROVED	BURROW BAITING APPROVED	PULSED BAITING APPROVED
Bromadiolone 0.005% (w/w)	Indoors and outdoors (around buildings), open areas and waste dumps.	Rats and Mice	Rats: Up to 225 g of bait per baiting point at 5 to 10 metre intervals.  Mice: 6-28g Per baiting point every at 2-4 metres apart.  Bait may be applied directly into burrows	Yes	Yes	No

## DEADLINE ALPHA EXPRESS UK AUTHORISATION NUMBER GB-2013-0803

ACTIVE % & TYPE	AREA OF USE	EFFECTIVE AGAINST	DOSAGE / QUANTITY GUIDE	PERMANENT BAITING APPROVED	BURROW BAITING APPROVED	PULSED BAITING APPROVED
Alphachloralose 4 % (w/w)	Indoors only.	Mice	Load each bait station with one or two 5 g blocks up to a maximum bait point size of 10 g. Bait stations are manually placed in the rodent infested area, in covered and protected positions at distances of no more than 3 metres apart.	No	No	No

## DEADLINE BROMADIOLONE WHOLE WHEAT UK AUTHORISATION NUMBER GB-2014-0826-0005

ACTIVE % & TYPE	AREA OF USE	EFFECTIVE AGAINST	DOSAGE / QUANTITY GUIDE	PERMANENT BAITING APPROVED	BURROW BAITING APPROVED	PULSED BAITING APPROVED
Bromadiolone 0.005 % (w/w)	Indoors and outdoors (around buildings), outdoor open areas and sewers.	Rats and Mice	Rats: Secure up to 250 g of product in a covered tamper resistant baiting stations or covered bait points spaced 10 m apart (5 m apart in areas of high infestation)  Sewers: Up to 300 g per manhole.  Mice: Secure 50 g of product in a covered tamper resistant baiting stations or covered bait points spaced 10 metres apart (5 m apart in areas of high infestations).	Yes	Yes	No

## DEADLINE DIFENACOU M PASTE UK AUTHORISATION NUMBER GB-2011-0148

ACTIVE % & TYPE	AREA OF USE	EFFECTIVE AGAINST	DOSAGE / QUANTITY GUIDE	PERMANENT BAITING APPROVED	BURROW BAITING APPROVED	PULSED BAITING APPROVED
Difenacoum 0.005 % (w/w)	Indoors and outdoors (around buildings).	House Mice ( <i>Mus musculus</i> )	Secure up to 8 g of product in covered tamper resistant baiting stations or covered bait points spaced 10 m apart (5 m apart in high infestation areas) in areas where mice are active.	Yes	No	No



DEADLINE DIFENACOU M WHOLE WHEAT				UK AUTHORISATION NUMBER GB-2011-0143-0001		
ACTIVE % & TYPE	AREA OF USE	EFFECTIVE AGAINST	DOSAGE / QUANTITY GUIDE	PERMANENT BAITING APPROVED	BURROW BAITING APPROVED	PULSED BAITING APPROVED
Difenacoum 0.005% (w/w)	Indoors and outdoors around buildings, in sewers and outdoor open areas.	Rats and Mice	Mice: ( <i>Mus musculus</i> ): Secure up to 50 g of product in covered tamper resistant baiting stations or covered bait points spaced 10 m apart (5 m apart in high infestation areas).  Rats: Secure up to 200 g of product in covered tamper resistant baiting stations or covered bait points spaced 10m apart (5 m apart in areas of high infestation) in areas where rats are active.	Yes	Yes	No

DETEX BLOCK WITH LUMITRACK				UK AUTHORISATION NUMBER N/A		
ACTIVE % & TYPE	AREA OF USE	EFFECTIVE AGAINST	DOSAGE / QUANTITY GUIDE	PERMANENT BAITING APPROVED	BURROW BAITING APPROVED	PULSED BAITING APPROVED
Non Toxic	Indoors and outdoors.	Rats and Mice	Rats: 3-6 Detex blox every 9-15 metres (30 to 50 Feet).  Mice: 1-2 Detex blox every 2-4 Metres (6 to 14 Feet).	N/A	N/A	N/A

HARMONIX RODENT PASTE				UK AUTHORISATION NUMBER GB-2020-1266; IE/BPA 70695		
ACTIVE % & TYPE	AREA OF USE	EFFECTIVE AGAINST	DOSAGE / QUANTITY GUIDE	PERMANENT BAITING APPROVED	BURROW BAITING APPROVED	PULSED BAITING APPROVED
Cholecalciferol 0.077% (w/w) (0.075% w/w pure)	Indoors, outdoor (around buildings) and outdoor (open areas and waste dumps) inc burrow baiting.	Rats and Mice	Rats: 100-200 g (5-10 sachets) bait per baiting point  Mice 20 g (1 sachet) bait per baiting point depending upon infestation level.	Yes	Yes	No

ROMAX B WHOLE WHEAT				UK AUTHORISATION NUMBER GB-2014-0826-0005		
ACTIVE % & TYPE	AREA OF USE	EFFECTIVE AGAINST	DOSAGE / QUANTITY GUIDE	PERMANENT BAITING APPROVED	BURROW BAITING APPROVED	PULSED BAITING APPROVED
Bromadiolone 0.005% (w/w)	Indoors and Outdoors (around buildings).	Rats and Mice	House Mice: High Infestations up to 50 g of bait per baiting point every 2 metres. Low Infestations up to 50 g of bait per baiting point every 5 metres.  Brown Rat: High infestations 100 g of bait per baiting point every 5 metres. Low Infestations 100 g of bait per baiting point every 10 metres.	Yes	No	No

## ROMAX D BLOCK UK AUTHORISATION NUMBER GB-2011-0065-0002

ACTIVE % & TYPE	AREA OF USE	EFFECTIVE AGAINST	DOSAGE / QUANTITY GUIDE	PERMANENT BAITING APPROVED	BURROW BAITING APPROVED	PULSED BAITING APPROVED
Difenacoum 0.005% (w/w)	Indoors and around buildings, in open areas, waste dumps and sewers.	Rats and Mice	Mice: 40 g every 5 m reducing to 2 m for high infestations.  Rats: 200 g every 10 m reducing to 5 m for high infestations	Yes	Yes	No

## ROMAX D WHOLE WHEAT UK AUTHORISATION NUMBER GB-2011-0143-0002

ACTIVE % & TYPE	AREA OF USE	EFFECTIVE AGAINST	DOSAGE / QUANTITY GUIDE	PERMANENT BAITING APPROVED	BURROW BAITING APPROVED	PULSED BAITING APPROVED
Difenacoum 0.005% (w/w)	Indoors and outdoors (around buildings), outdoors open areas and sewers.	Rats and Mice	Mice: Secure up to 50 g of product in a covered tamper resistant baiting station or covered bait points space 10 m apart (5 metres apart in high infestations).  Rats: Secure up to 200 g of product in a covered tamper resistant baiting station or covered bait points space 10 m apart (5 metres apart in high infestations).	Yes	Yes	No

## ROMAX DP PASTE UK AUTHORISATION NUMBER GB-2013-0804

ACTIVE % & TYPE	AREA OF USE	EFFECTIVE AGAINST	DOSAGE / QUANTITY GUIDE	PERMANENT BAITING APPROVED	BURROW BAITING APPROVED	PULSED BAITING APPROVED
Difenacoum 0.005% (w/w)	In and outdoors (around buildings).	Mice	Secure up to 4 g of bait into both corners of the bait box, as a guide place boxes 5 metres apart in high infestations and 10 metres apart for low infestations.	Yes	No	No

## ROMAX MUSKIL BLOCK FLUO-NP UK AUTHORISATION NUMBER GB-2013-0757

ACTIVE % & TYPE	AREA OF USE	EFFECTIVE AGAINST	DOSAGE / QUANTITY GUIDE	PERMANENT BAITING APPROVED	BURROW BAITING APPROVED	PULSED BAITING APPROVED
Bromadiolone 0.0025% (w/w) Difenacoum 0.0025% (w/w) Denatonium Benzoate 0.001% (w/w)	In and around buildings, in open areas, in waste dumps.	Rats and Mice	Mice: Use bait points of up to 50 g. Place bait 5 metres apart, reducing to 2 metres in areas of high infestations.  Rats: Use bait points of up to 100 g. Place bait points 10 metres apart, reducing to 5 metres in areas of high infestation.	Yes	Yes	No

## ROMAX MUSKIL PASTA SACHETS FLUO-NP

UK AUTHORISATION NUMBER  
GB-2013-0756

ACTIVE % & TYPE	AREA OF USE	EFFECTIVE AGAINST	DOSAGE / QUANTITY GUIDE	PERMANENT BAITING APPROVED	BURROW BAITING APPROVED	PULSED BAITING APPROVED
Bromadiolone 0.0025 % (w/w) Difenacoum 0.0025 % (w/w) Denatonium Benzoate 0.001 % (w/w)	Indoors and outdoors around buildings, open areas and waste dumps.	Rats and Mice	For the control of House Mice ( <i>Mus musculus</i> ) - for use indoors and outdoors around buildings: High infestation: up to 50 g of bait per baiting point spaced 2 m apart; Low infestation: up to 50 g of bait per baiting point spaced 5 m apart.  For the control of Brown Rats ( <i>Rattus norvegicus</i> ) - for use indoors and outdoors around buildings, in open areas and waste dumps: High infestation: up to 100 g of bait per baiting point spaced 5 m apart; Low infestation: up to 100 g of bait per baiting point spaced 10 m apart.	Yes	Yes	No

## ROMAX VENOM BLOCKS

UK AUTHORISATION NUMBER  
GB-2015-0880-003

ACTIVE % & TYPE	AREA OF USE	EFFECTIVE AGAINST	DOSAGE / QUANTITY GUIDE	PERMANENT BAITING APPROVED	BURROW BAITING APPROVED	PULSED BAITING APPROVED
Brodifacoum 0.005 % (w/w)	Indoors and Outdoors (around buildings).	Rats and Mice	House Mice: High infestations: Up to 50 g of bait per baiting point every 2 metres. Low Infestations: Up to 50 g of bait per baiting point spaced every 5 metres.  Brown Rats: High Infestations: Up to 100 g of bait per baiting point every 5 metres. Low infestations Up to 100 g bait per baiting point spaced every 10 m apart.	No	No	No

## ROMAX VENOM WHOLE WHEAT

UK AUTHORISATION NUMBER  
GB-2015-0883-004

ACTIVE % & TYPE	AREA OF USE	EFFECTIVE AGAINST	DOSAGE / QUANTITY GUIDE	PERMANENT BAITING APPROVED	BURROW BAITING APPROVED	PULSED BAITING APPROVED
Brodifacoum 0.005 % (w/w)	Indoors and Outdoors (around buildings).	House Mice and Brown Rats	House Mice: High infestations: Up to 50 g of bait per baiting point every 2 metres. Low Infestations: Up to 50 g of bait per baiting point spaced every 5 metres.  Brown Rats: High Infestations: Up to 100 g of bait per baiting point every 5 metres. Low infestations Up to 100 g bait per baiting point spaced every 10m apart.	No	No	No

## ROMAX VENOM PASTA

UK AUTHORISATION NUMBER  
GB-2015-0881-005

ACTIVE % & TYPE	AREA OF USE	EFFECTIVE AGAINST	DOSAGE / QUANTITY GUIDE	PERMANENT BAITING APPROVED	BURROW BAITING APPROVED	PULSED BAITING APPROVED
Brodifacoum 0.005 % (w/w)	Indoors and Outdoors (around buildings).	Rats and Mice	House Mice: High infestations: Up to 50 g of bait per baiting point every 2 metres. Low Infestations: Up to 50 g of bait per baiting point spaced every 5 metres.  Brown Rats: High Infestations: Up to 100 g of bait per baiting point every 5 metres. Low infestations Up to 100 g bait per baiting point spaced every 10 m apart.	No	No	No

## ROMAX VENOM LIPOGEL

UK AUTHORISATION NUMBER  
GB-2016-1041-0002

ACTIVE % & TYPE	AREA OF USE	EFFECTIVE AGAINST	DOSAGE / QUANTITY GUIDE	PERMANENT BAITING APPROVED	BURROW BAITING APPROVED	PULSED BAITING APPROVED
Brodifacoum 0.005% (w/w)	Indoors and outdoors (around buildings).	Rats and Mice	<p>House Mice (<i>Mus musculus</i>) High infestations: Up to 50 g of bait per bait point spaced 2 m apart. Low infestations: Up to 50 g bait per baiting point spaced 5 m apart.</p> <p>Brown Rat (<i>Rattus norvegicus</i>) High infestations: Up to 100 g per baiting point spaced 5 m apart. Low infestations: Up to 100 g per baiting points spaced 10 m apart.</p>	No	No	No

## RODILON WHEAT TECH

UK AUTHORISATION NUMBER  
GB-2011-0049-0001

ACTIVE % & TYPE	AREA OF USE	EFFECTIVE AGAINST	DOSAGE / QUANTITY GUIDE	PERMANENT BAITING APPROVED	BURROW BAITING APPROVED	PULSED BAITING APPROVED
Difethialone 0.0025% (w/w)	Indoors and Outdoors (around buildings).	Rats and Mice	<p>Mice: Place up to 50 g of bait in tamper-resistant bait stations or covered and protected baiting points spaced 2-3 m (low infestation) or 1-1.5 m (high infestation) apart in areas where mice are active (e.g. wherever damage, droppings or evidence of mice activity has been found).</p> <p>Rats: Place up to 200 g of bait, in tamper-resistant bait stations or covered and protected baiting points spaced 8 - 10 metres (low infestation) or 4-5 m (high infestation) apart in areas where rats are active (e.g. nesting areas, on rodent runs, along walls and where evidence of droppings have been found).</p>	No	No	No

## STORM SECURE BLOCKS

UK AUTHORISATION NUMBER  
GB-2015-0850

ACTIVE % & TYPE	AREA OF USE	EFFECTIVE AGAINST	DOSAGE / QUANTITY GUIDE	PERMANENT BAITING APPROVED	BURROW BAITING APPROVED	PULSED BAITING APPROVED
Flocoumafen (0.005% w/w)	In and around buildings and in sewers.	Rats and Mice	<p>Mice: Up to 20 g (1 block) per bait point placed 1-2 metres apart.</p> <p>Rats: 40-60 g (2-3 blocks) per bait point placed 5 - 10 metres apart.</p> <p>Burrow baiting: Up to 40-60 g (2-3 blocks) of bait per burrow.</p>	No	Yes	Yes

## STORM ULTRA SECURE BLOCKS

UK AUTHORISATION NUMBER  
GB-2018-1164-0001

ACTIVE % & TYPE	AREA OF USE	EFFECTIVE AGAINST	DOSAGE / QUANTITY GUIDE	PERMANENT BAITING APPROVED	BURROW BAITING APPROVED	PULSED BAITING APPROVED
Flocoumafen 0.0025% (w/w)	In and around buildings only.	House Mice ( <i>Mus musculus</i> ) Brown Rats ( <i>Rattus norvegicus</i> ) Black Rats ( <i>Rattus rattus</i> )	<p>Mice: 25 g per bait point spaced a minimum of 1-2 m apart.</p> <p>Rats: 50-75 g per bait point or burrow minimum distance 5-10 m apart.</p>	No	Yes	Yes





# A-Z INSECT control PRODUCTS

The following charts have been produced only as an aid in product selection. In all circumstances you should always read the product label. The information given is to the best of our knowledge and is given in good faith. We can not accept any responsibility for loss or damage arising from any error or omission. Certain information such as Personal Protective Equipment (PPE) requirements are only our recommendation and are provided as a guide and in no way should they replace any part of your COSHH assessment. Under certain conditions you may require additional PPE. You should always refer to the product MSDS before use.

## ALPHA SCT

ACTIVE %	SPECIES EFFECTIVE AGAINST	AREA OF USE	DILUTION/ DOSE RATES	APPLICATION TECHNIQUE	PPE REQUIRED	RESIDUAL OR KNOCKDOWN
Cypermethrin 10 % (w/w), Tetramethrin 0.9 % (w/w)	Flies, Moths, Beetles, Fleas, Ticks, Bed bugs, Cockroaches, Crickets, Silverfish, Booklice, Mites, Ants, Mosquitoes, Wasp and Centipedes.	For use in and around domestic properties, public and municipal areas, refuse tips, poultry houses, slaughterhouses and manure heaps.	Routine treatment - Dilute 25 ml in 5 L of water and apply at a rate of 50 ml per sq/m - Heavy infestations: Dilute 50 ml in 5 L of water and apply at a rate of 50 ml per sq/m.	A suitable hand or mechanical sprayer can apply as a coarse spray and apply at a rate of 50 ml per sq/m.	Coveralls, synthetic rubber/ PVC gloves, face shield - If spraying in confined places, full face mask or half mask with goggles and suitable filters.	Residual surface spray.

## AQUAPY

ACTIVE %	SPECIES EFFECTIVE AGAINST	AREA OF USE	DILUTION/ DOSE RATES	APPLICATION TECHNIQUE	PPE REQUIRED	RESIDUAL OR KNOCKDOWN
Chrysanthemum Cinerariaefolium Extract 3.00 % (w/w) synergised with Piperonyl Butoxide	Flying Insects, e.g. Flies, Mosquitoes, Stored product moths and Tobacco beetles - Wasps-by treating in and around the nest - Crawling Insects: as an aid to the control of, e.g. Cockroaches, Bed bugs, Fleas, Saw-toothed grain beetles, Grain weevils, Flour beetles, Grain borers, Mealworm beetles, Leather beetles and Tobacco beetles.	Domestic private dwellings - Food Handling: Processing, Food manufacture, Kitchens, Slaughterhouses, Bakeries, Mills etc. - Storage: Food retailers, Warehouses, Raw material stores etc. - Preparation: Restaurants, Commercial kitchens.	Ready to use please refer to product label for application rate.	Can be used indoors and outdoors as a space spray, surface, mist / fog or ULV application.	Full face mask or half mask with goggles, chemical-resistant gloves and coveralls.	Residual effect depends on dilution rates used - Refer to label for full details.

## BIOPREN 6 EC

ACTIVE %	SPECIES EFFECTIVE AGAINST	AREA OF USE	DILUTION/ DOSE RATES	APPLICATION TECHNIQUE	PPE REQUIRED	RESIDUAL OR KNOCKDOWN
s-Methoprene 6.74 % (w/w), Pyrethrin 4.81 % (w/w), Piperonyl Butoxide 10.17 % (w/w)	Bed bugs and Fleas, both as a flushing agent and knockdown insecticide.	For indoor use against Blood sucking insects (Bed bugs & Fleas) and other crawling insects in surfaces, cracks, crevices, carpets, soft furnishings, mattresses, pet housing and pet bedding.	Bed bugs-dilute 1 ml of product to 100 ml of water - Fleas-dilute 1ml of product to 250 ml water.	A suitable hand or mechanical compression sprayer.	Full face mask or half mask with goggles, chemical-resistant gloves or coveralls.	Residual.

## BIOPREN BMS

ACTIVE %	SPECIES EFFECTIVE AGAINST	AREA OF USE	DILUTION/ DOSE RATES	APPLICATION TECHNIQUE	PPE REQUIRED	RESIDUAL OR KNOCKDOWN
s-Methoprene 0.05 % (w/w)	Pharaoh ant	In and around the Home, Food industry areas, Bakeries, Butcher's shops, Hotels, Hospitals, Restaurants and similar establishments.	1-2 bait stations / 5 sq/m (depending on level of infestation).	Ready-to-use - just cut off top on the dotted line and stick each station along Ant runs or near nests.	Wear suitable protective clothing and gloves.	Knockdown.

## CIMETROL RFU

ACTIVE %	SPECIES EFFECTIVE AGAINST	AREA OF USE	DILUTION/ DOSE RATES	APPLICATION TECHNIQUE	PPE REQUIRED	RESIDUAL OR KNOCKDOWN
Cypermethrin 0.1% (w/w) , Pyriproxyfen 0.01% (w/w), Chrysanthemum Cinerariaefolium 0.05% (w/w)	Ants, Beetles, Mites, Cockroaches, Fleas, Flies, Mosquitoes, Wasps, Moths and Bed bugs.	For use indoors on non-porous surfaces, crack and crevices, hard and soft furnishings, including mattresses and carpets, in hospitals (excl. occupied wards), offices, industrial premises, museums, aircraft, ships and military installations. For Outdoor use on Ant and Wasp nests.	Space Treatment- 1 ml of product per m <sup>2</sup> as a fine mist - Surface Spray- apply 20 ml of product per m <sup>2</sup> slightly wetting the surface to be protected - Repeat treatment as and when required .	Ready-to-use aerosol.	Full face mask or half mask with goggles, chemical-resistant gloves or coveralls.	Knockdown.

## CIMETROL SUPER EW

ACTIVE %	SPECIES EFFECTIVE AGAINST	AREA OF USE	DILUTION/ DOSE RATES	APPLICATION TECHNIQUE	PPE REQUIRED	RESIDUAL OR KNOCKDOWN
Cypermethrin 25% (w/w), Tetramethrin 10% (w/w), Piperonyl Butoxide 20% & Pyriproxyfen 1% (w/w) of insect growth regulator	Bed bugs, Fleas, Cockroaches, Beetles (inc. larvae), Flies, Mosquitoes, Moths (inc. larvae) and Wasps.	For use inside all domestic, commercial, and industrial premises, including Kitchens, Hotels, Dormitories (inc. sleeping areas), Hospitals (excl. occupied wards), Military establishments, Food storage (inc. Processing areas).	Crawling Pests (Routine Treatments): 25 ml of product to 5 L of water - Crawling Pests (Heavy infestations): 50 ml of product to 5 L of water - Flying Insects (Routine Treatments): 25 ml of product to 5 L of water - 1 L of ready-to-use solution treats 20 m <sup>2</sup> .	Compression Sprayer, apply as a coarse, low-pressure spray.	Full face mask or half mask with goggles, chemical-resistant gloves or coveralls.	Excellent residual and knockdown with flushing effect, plus long period of control due to IGR.

## CROP PROTECT 25EC MAPP: 20530

ACTIVE %	SPECIES EFFECTIVE AGAINST	AREA OF USE	DILUTION/ DOSE RATES	APPLICATION TECHNIQUE	PPE REQUIRED	RESIDUAL OR KNOCKDOWN
25 g/L Deltamethrin, 225 g/L Piperonyl Butoxide	Crawling insects such as grain weevils, flour beetles, grain borers, sawtoothed grain beetles and bean weevils. Flying insects such as warehouse moths, rice moths, Indian meal moths and grain moths.	For use on crop handling equipment and storage structures, as well as a direct admixture for grain and pulses.	Handling equipment and storage structure: 0.6 ml/m <sup>2</sup> Admixture: 10 ml/tonne Maximum one treatment/year.	Apply using suitable hand or mechanical compression sprayer.	Full face mask or half face mask with goggles, chemical resistant gloves and coveralls.	Residual.

## CYTROL FORTE 10 g SACHETS

ACTIVE %	SPECIES EFFECTIVE AGAINST	AREA OF USE	DILUTION/ DOSE RATES	APPLICATION TECHNIQUE	PPE REQUIRED	RESIDUAL OR KNOCKDOWN
Cypermethrin 40% (w/w)	For use against Cockroaches, Fleas, Ants, Bed bugs, Silverfish, Woodlice, Earwigs, Millipedes, Centipedes, Houseflies, Clusterflies, Mosquitoes and Wasps.	In and Around Domestic and Industrial establishments, Hospitals (excl. occupied wards), Military areas, Restaurants and Eateries (not for use on Food preparation areas), Stores, Storage areas, Slaughterhouses, Refuse tips, Dustbins & around Manure heaps.	Crawling Insects (Routine Treatment): 10 g in 5 L of water (Heavy infestation): 20 g in 5 L of water Flying Insects 10 g in 5 L of water	Apply as a coarse, low-pressure spray.	Full face mask or half mask with goggles, chemical-resistant gloves or coveralls.	Good residual effect.

## DECIS

ACTIVE %	SPECIES EFFECTIVE AGAINST	AREA OF USE	DILUTION/DOSE RATES	APPLICATION TECHNIQUE	PPE REQUIRED	RESIDUAL OR KNOCKDOWN
Deltamethrin 1.5 % (w/w)	Aphids, Caterpillars and other agricultural/ horticultural pests.	See label for details	See label for details	Apply using knapsack or compression sprayer.	Full face mask or half mask with goggles and chemical-resistant gloves and coveralls.	Residual.

## FLYING INSECT KILLER

ACTIVE %	SPECIES EFFECTIVE AGAINST	AREA OF USE	DILUTION/DOSE RATES	APPLICATION TECHNIQUE	PPE REQUIRED	RESIDUAL OR KNOCKDOWN
d-Tetramethrin 0.15 % (w/w) and 1R-Trans Phenothrin 0.15 % (w/w) Also contains propellants: Propane, butane and isobutane.	A pre-pressurised handheld aerosol for use against Flying insects such as Flies, Mosquitoes and other small flying insects by application as a space and surface spray - Can also be used against crawling insects such as Ants, Bed bugs, Cockroaches and Fleas.	Indoors only.	Refer to label.	Ready-to-use aerosol.	Wear suitable protective clothing and suitable gloves.	Rapid control and quick knockdown.

## FLY SELECT

ACTIVE %	SPECIES EFFECTIVE AGAINST	AREA OF USE	DILUTION/DOSE RATES	APPLICATION TECHNIQUE	PPE REQUIRED	RESIDUAL OR KNOCKDOWN
Aramethiphos 1%	Flies	Window Sills, near Animal Pens in Barns, Poultry Houses, other Livestock Houses and Agricultural Buildings.	Granules are to be spread in a thin layer on horizontal surfaces such as paper or cardboard or placed in dishes - indoor use only.	For use indoors only.	Wear suitable protective gloves - avoid contact with skin.	Knockdown

## FLYMAX ULV

ACTIVE %	SPECIES EFFECTIVE AGAINST	AREA OF USE	DILUTION/DOSE RATES	APPLICATION TECHNIQUE	PPE REQUIRED	RESIDUAL OR KNOCKDOWN
Methyl cellulose -2%	Flying and crawling insects	Indoors, outdoors and around buildings	Apply undiluted as a ULV fog directed at insects at 10 ml per 36 m <sup>2</sup> (10 ml per 100 m <sup>3</sup> )	ULV	Full face or half mask with goggles, chemical resistant gloves and coveralls.	Knockdown



## FORTEFOG MAXI FUMER

ACTIVE %	SPECIES EFFECTIVE AGAINST	AREA OF USE	DILUTION/DOSE RATES	APPLICATION TECHNIQUE	PPE REQUIRED	RESIDUAL OR KNOCKDOWN
Permethrin 13.25%	Flying insects (e.g. moths, flies, mosquitoes, wasps) Crawling Insects (e.g. fleas, bed bugs, ants, cockroaches and stored product insects including saw tooth grain beetle and adult grain weevils)	Indoors	Flying insects: 1 fogger/1000 m <sup>3</sup> Crawling insects (fleas/ bedbugs): 1 fogger/250 m <sup>3</sup> Crawling insects (cockroaches/ants): 1 fogger/ 62.5 m <sup>3</sup>	Ready to use smoke generator - refer to label information before ignition	Full face mask or half face mask with goggles, chemical resistant gloves and coveralls	Knockdown.

## FORTEFOG MINI FUMER

ACTIVE %	SPECIES EFFECTIVE AGAINST	AREA OF USE	DILUTION/DOSE RATES	APPLICATION TECHNIQUE	PPE REQUIRED	RESIDUAL OR KNOCKDOWN
Permethrin 13.25%	Flying insects (e.g. moths, flies, mosquitoes, wasps) Crawling Insects (e.g. fleas, bed bugs, ants, cockroaches and stored product insects including saw tooth grain beetle and adult grain weevils)	Indoors	Flying insects: 1 fogger/120 m <sup>3</sup> Crawling insects (fleas/ bedbugs): 1 fogger/30 m <sup>3</sup> Crawling insects (cockroaches/ants): 1 fogger/ 7.5 m <sup>3</sup>	Ready to use smoke generator - refer to label information before ignition	Full face mask or half face mask with goggles, chemical resistant gloves and coveralls	Knockdown.

## MITEMAX READY-TO-USE

ACTIVE %	SPECIES EFFECTIVE AGAINST	AREA OF USE	DILUTION/DOSE RATES	APPLICATION TECHNIQUE	PPE REQUIRED	RESIDUAL OR KNOCKDOWN
Aqueous Cellulose polymer (contains Isopropanol)	Poultry red mite.	Apply to the structure and surfaces of Poultry shed inc. dusty areas where Mites are harbouring.	Ready-to-use. Apply to run off	Supplied in ready-to-use trigger pack.	Wear face protection and gloves.	Immobilisation and knockdown.

Whilst you are here...  
Follow us on Facebook!

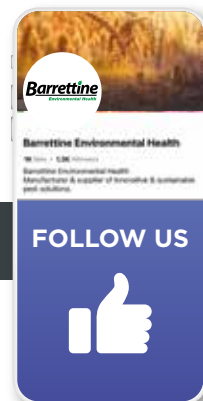

Keep up to date with our latest products and deals!



EXPLORE OUR WEEKLY POSTS



LATEST PRODUCTS & PROMOTIONS

FOLLOW US



## MoBe® ANT GEL BAIT

ACTIVE %	SPECIES EFFECTIVE AGAINST	AREA OF USE	DILUTION/DOSE RATES	APPLICATION TECHNIQUE	PPE REQUIRED	RESIDUAL OR KNOCKDOWN
Imidacloprid 0.01%	Tropical Ants, Argentine Ants, Black Ants	Indoors and Outdoors	Indoors: 0.2-0.4g/m <sup>2</sup> Outdoors: 0.2g/m <sup>2</sup>	Apply using suitable bait gun/ applicator	Chemical resistant gloves	Knockdown and residual.

## MoBe® ANT STATION

ACTIVE %	SPECIES EFFECTIVE AGAINST	AREA OF USE	DILUTION/DOSE RATES	APPLICATION TECHNIQUE	PPE REQUIRED	RESIDUAL OR KNOCKDOWN
Imidacloprid 0.01%	Tropical Ants, Argentine Ants, Black Ants	Indoors and Outdoors	One station /4 m <sup>2</sup> along foraging trails	Station is supplied ready to use	Chemical resistant gloves	Knockdown and residual.

## MoBe® ROACH GEL BAIT

ACTIVE %	SPECIES EFFECTIVE AGAINST	AREA OF USE	DILUTION/DOSE RATES	APPLICATION TECHNIQUE	PPE REQUIRED	RESIDUAL OR KNOCKDOWN
Imidacloprid 2.15%	German Cockroach and Oriental Cockroach	Indoors only	German Cockroach: 0.1 - 0.2g/m <sup>2</sup> Oriental Cockroach: 0.2 - 0.3g/m <sup>2</sup>	Apply using suitable bait gun/ applicator	Chemical resistant gloves	Knockdown and residual.

## OA2KI CONCENTRATE & OA2KI READY-TO-USE

ACTIVE %	SPECIES EFFECTIVE AGAINST	AREA OF USE	DILUTION/DOSE RATES	APPLICATION TECHNIQUE	PPE REQUIRED	RESIDUAL OR KNOCKDOWN
Aqueous cellulose polymer	Ants, Bed bugs, Fleas, Flies and small insects.	Refer to product label.	Concentrate only: 1 part concentrate to 7.5 parts water - 500 ml of Concentrate makes 4.25 litres of ready-to-use product.	As a surface spray-use a knapsack / compression sprayer-apply as a medium spray - As a space spray-apply through a suitable ULV or fogging equipment that can dispense water-based products.	Wear face protection and gloves.	Knockdown.

OA2KI POWDER						
ACTIVE %	SPECIES EFFECTIVE AGAINST	AREA OF USE	DILUTION/ DOSE RATES	APPLICATION TECHNIQUE	PPE REQUIRED	RESIDUAL OR KNOCKDOWN
Diatomaceous Earth	Effective in desiccating areas where applied.	Domestic, Commercial, Public and Institutional premises, inc. Kitchens and Food preparation/ manufacturing areas.	For public health pest-apply as required to cracks and crevices 10-30 g per m <sup>2</sup> .	Apply using a suitable mechanical or electric dust applicator or via a puffer pack.	1/2 mask with goggles, chemical-resistant gloves and coveralls.	Extremely residual. If product is applied to dry, clean and undisturbed environments.

OA2KI AEROSOL - SD						
ACTIVE %	SPECIES EFFECTIVE AGAINST	AREA OF USE	DILUTION/ DOSE RATES	APPLICATION TECHNIQUE	PPE REQUIRED	RESIDUAL OR KNOCKDOWN
Silicon Dioxide	Bed bugs.	Domestic and Commercial - cracks and crevices.	Ready-to-use. Apply liberally.	Apply directly from aerosol hold 30 cm away from surface - One can covers 9 m <sup>2</sup> .	1/2 mask with goggles, chemical-resistant gloves and coveralls.	Residual.

PERMOST UNI FLY SPRAY						
ACTIVE %	SPECIES EFFECTIVE AGAINST	AREA OF USE	DILUTION/ DOSE RATES	APPLICATION TECHNIQUE	PPE REQUIRED	RESIDUAL OR KNOCKDOWN
Permethrin 0.31 % (w/w) Tetramethrin 0.124 % (w/w)	Flies, Mosquitoes, Wasps, Ants, Cockroaches, Earwigs, Fleas, Bristletails, Beetles, Mites, Ticks and Fleas.	Hospitals (excl. occupied wards), Military barracks, Milk rooms, Avian housing and Refuse tips.	1 L of product sufficient to treat 1,000 m <sup>2</sup> .	Hand Sprayer or Fogger.	1/2 mask with goggles, chemical-resistant gloves and coveralls.	Knockdown.

PROTECTOR ONE SHOT						
ACTIVE %	SPECIES EFFECTIVE AGAINST	AREA OF USE	DILUTION/ DOSE RATES	APPLICATION TECHNIQUE	PPE REQUIRED	RESIDUAL OR KNOCKDOWN
Pyrethrin 0.2 % (w/w)	For the control of flying insects such as Flies, Mosquitoes, Ants, Cockroaches, Wasps, Earwigs, Silverfish (inc. other bristletails), Fleas, Beetles, Bed bugs, Moths, Booklice, Mites (inc. Dust mites).	Use in domestic & commercial situations, inc. kitchens, hospitals (not occupied wards), hotels, restaurants, public & municipal buildings & onboard ships, for use outdoors on patios, paths amenity areas, transit stations, refuse tips & wasp nests. In & around farm buildings.	Ready-to-use aerosol.	Ready-to-use aerosol.	Full face or 1/2 mask with goggles. chemical-resistant gloves and coveralls.	Knockdown.

# INSECT control

PRODUCTS

A-Z

## VULCAN P5

ACTIVE %	SPECIES EFFECTIVE AGAINST	AREA OF USE	DILUTION/DOSE RATES	APPLICATION TECHNIQUE	PPE REQUIRED	RESIDUAL OR KNOCKDOWN
Permethrin 0.05 % (w/w)	Fleas, Lice, Mites, Ticks, Cockroaches, Earwigs, Beetles (inc. larvae), Moths (inc. larvae), Bed bugs, Ants, Woodlice, Silverfish and Wasps.	In and Around buildings.	10-25 g per m <sup>2</sup> .	Dusting applicator.	Full face mask or 1/2 mask with goggles, chemical-resistant gloves and coveralls.	Residual and knockdown.

## XLARV

ACTIVE %	SPECIES EFFECTIVE AGAINST	AREA OF USE	DILUTION/DOSE RATES	APPLICATION TECHNIQUE	PPE REQUIRED	RESIDUAL OR KNOCKDOWN
A unique silicone based liquid for Mosquito, Larvae and Pupae control.	Can be used on all mosquito species; the film prevents pupae and larvae from attaching themselves at the surface while attempting to breathe, thereby causing them to drown.	For use on Open water bodies and Underground systems.	Refer to product label.	Refer to product label.	Refer to product label.	Refer to product label.

## TECHNICIANS FIELD GUIDE

A complete and essential guide for the professional.

FLYING INSECTS

CRAWLING INSECTS

RODENT PESTS

BIRD PESTS

SPI, AGRICULTURE & AMENITY PESTS

The Barretts' pocket-size A6 Pest Technicians guide contains detailed information to assist in the daily routine of a Professional Pest Control Operator: A 'how to' guide covering topics of insect and rodent information and identification, equipment calibration, non-chemical insect control measures, pesticide application and product safety, dealing with waste: Triple rinsing as well as detailed information on LD<sub>50</sub>.

ORDER CODE: BPIDBOOK



A-Z INSECTICIDE & INSECT CONTROL PRODUCTS



# WATER VOLE PROTECTION



## KNOW YOUR VOLE

Water voles are easily confused with rats. Rats are treated as pests but water voles are a legally protected species. How can pest control affect water voles? Controlling pests such as rats may lead to accidental destruction of water vole colonies. Damage occurs when water voles are mistaken for rats, or when control methods are used carelessly. Rats sometimes prey on young water voles so careful rat control can benefit water vole colonies.

## WHAT THE LAW SAYS

Is it an offence to intentionally or recklessly damage, destroy or obstruct access to any structure or place that a water vole uses for shelter or protection. It is also an offence to disturb a water vole while it is using such a place. (Wildlife and Countryside Act 1981, Schedule 5, Section 9[4]). Blocking water vole burrows is illegal. Placing traps or bait boxes into or in the way of water vole burrows could lead to prosecution. Offences carry a maximum penalty of £5000. The court may also take any vehicle or other equipment used to commit the offence.

## THREATS TO WATER VOLES

Water voles have suffered the most dramatic decline of any British mammal in the last century. There is now only one vole for every 20 that were alive in 1900. The main causes for this decline have been loss and damage to habitat, and predation by American mink. Any activity that poses the slightest threat to water voles must therefore be undertaken with extreme care.

## THREATS TO WATER VOLES

If you are controlling pests near water, check for signs of water voles before starting. Your local Wildlife Trust may be able to provide information on water vole presence at the site. Both water voles and rats burrow into the banks of most types of waterway. Water voles are usually restricted to within several meters of the waters edge. Use the chart below to check for signs of water voles. If you find water voles and rats follow the advice in the leaflet. If in doubt, contact your local Wildlife Trust.

### WATER VOLE (*Arvicola terrestris*)

<b>SIZE &amp; SHAPE</b>	Water voles have rounded bodies and grow to 320 g, smaller than an adult male rat.
<b>COLOUR</b>	Water voles are generally mid-brown in colour with silky fur. Dark brown or black individuals may occur, especially in uplands.
<b>SNOUT, EARS AND TAIL</b>	Water voles have short blunt snouts. Their ears are almost hidden by fur. Their furry tail is two thirds of their body length.
<b>BURROWS</b>	Water voles have short blunt snouts. Their ears are almost hidden by fur. Their furry tail is two thirds of their body length.
<b>PATHS</b>	Usually one main track along water's edge, with some paths pushing up into vegetation higher up the bank. Paths are normally concealed in grass and stay near the water.
<b>DROPPINGS</b>	Between spring and autumn droppings are left in piles of 5-100 usually within 30 cm of water. In winter droppings are dispersed. Droppings are 5-10 mm long and rounded at both ends. They have a putty-like texture, with very fine plant material visible. Green, brown, purplish or black in colour. No strong odour.
<b>FEEDING REMAINS</b>	The diet of water voles is mainly vegetarian. Water voles leave small piles of chopped vegetation (approx. 10cm long and cut at 45 degree angle with grooved teeth-marks at ends) at feeding sites on banks.
<b>ACTIVITY</b>	Can be active during the day but more likely to be seen at dawn and dusk.
<b>FOOTPRINTS</b>	Not a reliable guide.

### BROWN RAT (*Rattus norvegicus*)

<b>SIZE &amp; SHAPE</b>	Rats are bigger than water voles. Adult males weigh up to 500 g.
<b>COLOUR</b>	Grey or brown with a paler underside.
<b>SNOUT, EARS AND TAIL</b>	8-10 cm diameter burrows may occur well away from the water's edge often with a heap of soil in a 'fan' shape outside the entrance.
<b>BURROWS</b>	A network of well trampled paths connecting all burrows. Paths may lead across open land away from the water.
<b>PATHS</b>	A network of well trampled paths connecting all burrows. Paths may lead across open land away from the water.
<b>DROPPINGS</b>	One or several left on paths or at the water's edge. Droppings are 12-15 mm long, flat at one end and pointed at the other. Slimy or very soft texture, occasionally granular. Light brown to black in colour. Unpleasant odour of urine or ammonia.
<b>FEEDING REMAINS</b>	Rats are opportunist feeders and will eat a variety of foods. Remains of meals such as broken snail shells are sometimes found on the riverbank.
<b>ACTIVITY</b>	Largely nocturnal.
<b>FOOTPRINTS</b>	Not a reliable guide.

# TERMS & CONDITIONS

## TERMS & CONDITIONS

1. All products are offered for sale subject to our standard conditions of sale. Full terms and conditions are available on request.
2. All prices quoted are exclusive of VAT and are subject to alteration without notice.
3. We would especially draw your attention to the following standard conditions:  
Nett Cash Monthly to Approved Accounts. Carriage is paid on orders of £245 or more for standard next day delivery, unless otherwise specified.  
For orders of a lesser value a small surcharge of £9.85 per invoice will be raised to meet cost of processing small orders. Carriage is charged at cost to deliveries off the mainland such as offshore islands.
4. Notification of non-delivery must be made in writing within seven days from the date of despatch of the goods or else claims cannot be entertained.
5. Barretine cannot take responsibility for any associated costs arising from delivery issues (such as late or failed delivery), or delivery of wrong items and neither Barretine, nor our courier company take any responsibility if the clients request we leave goods unsigned.
6. Returns Policy - Should you return the Goods in accordance with our Terms & Conditions stated above, we reserve the right to charge a "restocking fee" which will be an amount equivalent to 15% of the price payable by you in respect of the returned Goods.

Should you wish to return anything bought from us, we will be happy to refund or exchange a product provided it is in a fully resaleable condition however you will be responsible for the postage and any associated cost and risk of the return of the goods to us.

If you wish to return your order we must receive notification within 14 calendar days from receipt of your goods. If we find that the product has not been returned to us in a fully resaleable condition, we reserve the right to refuse a refund on the item.

## SPECIAL CONDITIONS OF SALE

### Poisons

These products are subject to the Poisons Rules and can only be supplied to authorised purchasers against a signed official order stating the purpose of which it is to be used.  
Please note: These items cannot normally be supplied on a next day delivery.

### Pesticides

All pesticides listed are approved by ministers under the Control of Pesticides Regulations 1986 and the Control of Pesticides Regulations (Northern Ireland) 1987. Control of Pesticides - superseded by the European Biocides Directive where appropriate.

The Health and Safety Executive (HSE) in the United Kingdom is responsible for administering the Control of Pesticides Regulations (COPR) regulatory scheme in relation to non-agricultural pesticides and is also responsible for regulating biocides in the UK. The Control of Pesticides Regulations 1986 (COPR) (as amended 1997) with products controlled under COPR are gradually moving over to be regulated under the Biocidal Product Register (BPR), with COPR eventually becoming redundant. In addition to the COPR and the BPR, Article 95 of EU BPR (as amended) introduces an approved active substance supplier list. Article 95 of EU BPR applies to all products that are approved under the Control of Pesticides Regulations (COPR). Article 95 (2) of EU BPR (as amended) states "As of 1 September 2015, a biocidal product consisting of, containing or generating a relevant substance, included in the list referred to in paragraph 1, shall not be made available on the market unless either the substance supplier or the product supplier is included in the list referred to in paragraph 1 for the product-type(s) to which the product belongs."

Efficacy: Biocidal and non-biocidal products have varying rates of efficacy in the field and product labels should always be referred to in order to maximise efficacy.

# INDEX

## A

A2, P3 - 3M Filters	72
Aerosols	48
Alpha Express Blocks	14
Alpha SCT Concentrate	44
Application Equipment	61-69
Applicator Guns	68
Ant Baits	36
Ant Bait Stations	37
Ant Control	36-38
Ant Killer Gel	36
Anti-Rodent Lacquer	21
AquaPy	31
Avisil Adhesive	58
A-Z Insecticides	84-91
A-Z Rodenticides	78-83

## B

Bait Boxes	16-18
Bait Box Anchors	19
Bait Box Fixings	19
Bait Box Insect Monitor	19
Bait Box Keys	16
Bait Box Labels	28
Bait Guns	68
Bait Trays	19
Biopren BMS	36
Biopren 6 EC	45
Bird Control	54-60
Bird Dishes	55
Bird Proofing	57-58
Bird Spikes	57
Bird Spike Clips	58
Bird Repellent	55
Bird Traps	59
Bird Waste Cleaning	55-60

## C

Cardboard Bait Box	18
Cartridge Masks	72
Cartridge Mask Filters	72
Caulking Gun	68
Caustic Soda	75
Cimetrol Super EW	44
Cimetrol Super RFU	48
CL Trac	41
Cleaning	74-75
Clipper Steel Wire Wool	23
Clothes Moth Insect Monitors	41

Cockroach Baits	36
Cockroach Traps	38
Tri-Jet Fogger	62
ContraC Blox	11
Contact Station	10
Coveralls	71
CreoSolve	52
Crop Protect EC25	50
Cyrol Forte range	46

## D

Deadline Bromadiolone Wheat	11
Deadline Difenacoum Wheat	13
Deadline Difenacoum Paste	13
Decanting & Mixing	69
Decis Protech	46
Deodorising Products	62
Detex Blox with Lumitrack	15
Diatomaceous Earth	30
Difenacoum Rodenticides	13
Disinfectants	27-74
Disposable Coveralls	71
Disposable Wasp Bag	40
Drain Cleaner	75
Drainage Systems	27
Drain Unblocker	75
DR5 Duster	66
Dusters	66
Duster Spare Parts	67
Dust & Wettable Powders	46
Dust Applicators	66
DR5 Dust Applicator & spares	66
Dustick Applicator	67
Dustick Accessories	67
Dustick Bag	67

## E

Entrap	41
--------	----

## F

Face Mask	72-73
Face Mask 3M	73
Fenn Traps Mk 4	22
Field Guide	19
Filter 3M A1 & A2	72
Filters For Masks	72
Flymax ULV	32
Fly Select	57
Foggers	62

Fogmaster Junior	62
Fortefog Smoke Generators	48
Full Face Respirator	72
Fumigants and Accessories	48

## G

Gel Canteen	36
Gloria Sprayers & Spares	63-65
Gloves, Nitrile	71
Gloves	71
Glue Boards	25
Glue Release Agent	25
Glue Solvent	25
Grain Store Hygiene	50-51
Guanaway	55
Guano Cleaning	55

## H

Hand Sprayers	63
Harmonix Rodent Paste	10
Hygiene & Disinfectants	27, 74

## I

Insect Control	29-53
Insect floors & Sticky Pads	38
Insect Pheromones & Lures	41-42
Insecticide Concentrates	44-46
Insecticide Hand Sprayers	63
Insecticide Sprayers Spares	64-65

## L

Live Catch Traps & Proofing	23
-----------------------------	----

## M

Masks, Respirators & Filters	72
Max Strength Disinfectant	27 & 74
Measuring Scoop	69
Mesh for Rodents	23
MiteMax RTU	32
MoBe Combo Trap Mk.2	43
MoBe Ant Gel Bait	36
MoBe Ant Station	37
MoBe Moat	38
MoBe Roach Gel Bait	36
MoBe Roach Trap	38
Mole Traps	22
Moth Monitoring Trap & Lures	41-43

# INDEX

Moulded Respirators	73	Rodent Mesh	23	Storm Ultra	14
Mouse Bait Stations	18	Rodent Repellents	21		
Mouse Mesh Grills	23	Rodent Spring Traps	20	<b>T</b>	
Muskil Blocks	5	Rodent Proofing	23	Talpex Mole Trap	22
Muskil Pasta	5	Rodent Traps	20	Technicians Field Guide	19
		Rodenticides	5-14	Terms and Conditions	93
<b>N</b>		Rodenticides-Alphachloralose	14	Tobacco Beetle & Moth Traps	43
Nozzles - adjustable rotate	23	Rodenticides-Brodifacoum	9	Torches & Tools	69
		Rodenticides-Bromodiolone	11	Tracking Dust	15
<b>O</b>		Rodenticides-Brom/Difen	11-12	Tracking Dust & Torch	15
Oa2ki Aerosol	30	Rodenticides-Cholecalciferol	10	Trap Funnels	59
Oa2ki Concentrate & Powder	30	Rodenticides-Coumatetralyl	10	Trappit BB Detector Plus	37
Ornaway Bird Repellent	55	Rodenticides-Difelhialone	13	Treatment Report Pads	28
		Rodenticides-Difenacoum	12-13		
<b>P</b>		Rodenticides-Flocoumafen	14	<b>U</b>	
P3 Filter	72	Rodilon Wheat Tech	13	ULV Applicator	62
Paperwork and Labels	28	Romax B Whole Wheat	11	ULV Fogger	62
Pathway & Patio Cleaner	53	Romax D Bait Blocks	12	UV Torch	69
Permost Uni Fly Spray	45	Romax Bait Box Keys	16		
Personalised Labels	28	Romax Bait Stations	16	<b>V</b>	
Pesticide Free Technology	30-33	Romax Contact Station	10	Venom Lipogel Bait	7
Pigeon Traps	59	Romax D Block 25	12	Venom Pasta	7
Plastic Bait Trays	19	Romax D Wheat Sachets	12	Venom Wheat	7
Poison Labels	28	Romax D Whole Wheat	12	Vertebrate Trap	20, 22
PPE & Safety	70-73	Romax DP Paste	12	Vulcan P5 Wasp Dust	46
Pre-baited Clothes Moth Holder	41	Romax Glue Boards	25		
Proofing Materials	23	Romax Glue Solvent	25	<b>W</b>	
Proofing Mesh	23	Romax Mouse Box	18	Wasp Bag	40
Proofing Sealants	23	Romax Mouse Box Floor	18	Wasp Bait	40
Protective Clothing	71	Romax Muskil	5	Wasp & Fly Liquid	40
Protective Gloves	71	Romax Rodent Seal	23	Wasp and Fly Traps & lures	40
Protector One Shot	48	Romax Snap-R Mouse Box	18	Weils Card	16
Pybuthrin 33	50	Romax Snap-R Traps	20	Weldmesh	23
		Romax Tracking Dust	15	Wire Wool	23
<b>R</b>		Romax Venom Block	7	Wood Preservation	52-53
Racumin Foam	10	Romax Venom Lipogel	7	Wood Protective Treatments	53-53
Rat Traps	20	Romax Venom Pasta	7	Wood Rotting Fungi Treatment	52
Rat Wall & Accessories	27	Romax Venom Wheat	9		
Respirators	73	<b>S</b>		<b>X</b>	
Rodent Bait Stations	16	Sealant	23	Xlarv Mosquito Control	50
Rodent Cleaning Tools	27	Serrico Traps	43		
Rodent Control	4-28	Smoke Generators	48		
Rodent Deterrent/Lacquer	21	Snap Traps	20		
Rodent Drainage Systems	27	Spoon for Baiting	69		
Rodent Glue Boards	25	Sprayers	63		
Rodent Hygiene/Disinfectants	27	Sprayer Accessories	64-65		
Rodent Indicators	15	Sprayer Extensions	64-65		
Rodent Lures	21	Spring Traps	20		
		Stored Product Insect Traps	41-43		
		Storm Secure	14		



# DELIVERY OPTIONS

PLACE YOUR ORDER **BY 3:00 PM**  
TO TAKE ADVANTAGE OF OUR NEXT-DAY DELIVERY SERVICE



## EXPLORE OUR EXPEDITED DELIVERY OPTIONS

Enjoy the convenience of next-day delivery, before 9:30 am, noon and even Saturdays, available upon request. For more details, kindly contact our office.

## RAPID ORDER PROCESSING

Place a confirmed order by telephone before 3:00 pm Monday - Thursday and 2pm Friday, and your consignment will be dispatched on the same working day. Delivery timescales may vary based on courier performance and chosen delivery options.

## SERVICE COVERAGE

These services apply to the UK mainland (excluding Scotland) and are subject to product availability at the time of order. Feel free to collect your goods directly from our warehouse between 8:30 am and 4:00 pm every working day.

## COST CONSIDERATIONS

For orders exceeding £245.00 (excluding VAT), our standard delivery service is free of charge. A £9.85 (excluding VAT) fee applies to UK mainland only on orders below this amount.

## PAYMENT CONVENIENCE

Prefer paying via card? Order and pay online through our website, or simply call us with your Mastercard or Visa number, and your goods will be on their way.





## PEST, ENVIRONMENTAL & AGRICULTURAL SOLUTIONS

### WE DELIVER **WORLDWIDE**

#### **OUR SERVICE\***

Our Export department understands the requirements of our overseas customers and we offer a complete export service for our diverse range of products to global destinations.

Dependant on the goods and the destination, our export department manages the Free Sales Certification as well as Certificates of Origin, hazardous packing and dangerous goods notices. The goods can be couriered direct, via freight forwarders or as consolidated freight.



PEST, ENVIRONMENTAL  
& AGRICULTURAL  
SOLUTIONS



Manufactured in the UK